



Titus
+

Stefano Orlati Cabinet Handles

2nd Edition Catalogue

Stefano Orlati
Titus+

Aura

Cabinet Handles

Product Guide

Stefano Orlati Handles

	Page
Information	3
Bow Handles	4
Profile Handles	14
Provincial Handles	21
Recessed Handles	25
Square Handles	27
Stainless Steel Handles	46
Knobs	49
Push Open	57

Stefano Orlati Handles

Information

Colour Finish Guide

AB		Antique Bronze	MBN		Matt Brushed Nickel
ABS		Aluminium Brushed Satin	MC		Matt Chrome
AC		Antique Copper	MW		Matt White
AI		Antique Iron	P		Pewter
BA		Brushed Anthracite	PA		Pearl Anthracite
BC		Brushed Copper	PC		Polished Chrome
BLKN		Black Nickel	PG		Pearl Gold
BN		Brushed Nickel	S		Silver
BSAT		Brushed Satin Antique Tin	SB		Satin Brass
BSBN		Brushed Satin Black Nickel	SC		Satin Chrome
CG		Champagne Gold	SG		Satin Gold
CH		Chrome	SS		Stainless Steel
CL		Clear Glass	TG		Titanium Grey
CMB		Copper Matt Black	WH		White
FS		Foggy Silver	WHC		White Crackled Finish
G		Gold			
MB		Matt Black			

Guide to Handle Dimensions

Length: Overall length of the handle (mm)

Centre: Screw hole to screw hole (mm)

Height: Height/Projection of handle (mm)

Width: Width of handle face (mm)

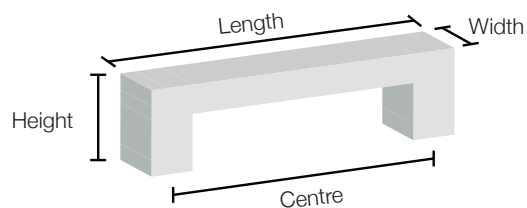



*All colours are for representation purposes only.
For an exact colour match, ensure you request a sample.*

Bow Handles





Stefano Orlati Handles

Bow Handles

	Centre (mm)	Length (mm)	Height (mm)	Width (mm)	Item number	Finish
122	160	180	26	18	SO-122-160 →	BN
						
<p>● BN</p>						
TSB	96	111	29	10	SO-TSB-96 →	MB
	96	111	29	10	SO-TSB-96 →	BN
	128	150	30	10	SO-TSB-128 →	BN
	96	111	29	10	SO-TSB-96 →	CH
	128	150	30	10	SO-TSB-128 →	CH
	96	111	29	10	SO-TSB-96 →	MC
	128	150	30	10	SO-TSB-128 →	MC
						
<p>● MB ● BN ● CH ● MC</p>						

Stefano Orlati Handles

Bow Handles







	Centre (mm)	Length (mm)	Height (mm)	Width (mm)	Item number	Finish
410 	96	112	28	10	608.8J20.096.004	MB
	96	112	28	10	608.8J20.096.013	MC
	128	144	35	10	608.8J20.128.013	MC
	96	112	28	10	608.8J20.096.003	BN
	128	144	35	10	608.8J20.128.003	BN
	224	288	37	10	608.8J20.224.003	BN
	96	112	28	10	608.8J20.096.007	CH
	128	144	35	10	608.8J20.128.007	CH
	224	288	37	10	608.8J20.224.007	CH
	96	112	28	10	608.8J20.096.008	SC
	128	144	35	10	608.8J20.128.008	SC
	224	288	37	10	608.8J20.224.008	SC
	96	112	28	10	608.8J20.096.012	BLKN
	128	144	35	10	608.8J20.128.012	BLKN
	224	288	37	10	608.8J20.224.012	BLKN
*Available only in AU						
KAVA 616 	96	114	23	17	SO-616-96 →	MB
	128	150	27	21	SO-616-128 →	MB
	192	226	31	23	SO-616-192 →	MB
	96	114	23	17	SO-616-96 →	TG
	128	150	27	21	SO-616-128 →	TG
	192	226	31	23	SO-616-192 →	TG
						

- MB ● MC ● BN
- PC ● SC ● BLKN

- MB ● TG

Stefano Orlati Handles

Bow Handles

	Centre (mm)	Length (mm)	Height (mm)	Width (mm)	Item number	Finish
LEVO 684   	K	32	25	32	SO-684-K →	CMB
	96	119	25	21	SO-684-96 →	CMB
	128	151	25	23	SO-684-128 →	CMB
782  	96	115	28	10	608.8F21.096.007	PC
	128	148	28	10	608.8F21.128.007	PC
	96	115	28	10	608.8F21.096.008	SC
	128	148	28	10	608.8F21.128.008	SC
1037 	128	158	29	10	SO-1037-128 →	BN
	128	158	29	10	SO-1037-128 →	CH
	128	158	29	10	SO-1037-128 →	MC

● CMB

● PC ● SC



*Available only in AU

● BN

● CH ● MC

Stefano Orlati Handles

Bow Handles

	Centre (mm)	Length (mm)	Height (mm)	Width (mm)	Item number	Finish
3130 	128	147	30	18	SO-3130-128 →	BN
	192	222	30	18	SO-3130-192 →	BN
	256	275	30	18	SO-3130-256 →	BN
	416	430	30	18	SO-3130-416 →	BN
	128	147	30	18	SO-3130-128 →	MB
	192	222	30	18	SO-3130-192 →	MB
	256	275	30	18	SO-3130-256 →	MB
	416	430	30	18	SO-3130-416 →	MB
	128	147	30	18	SO-3130-128 →	WH
	192	222	30	18	SO-3130-192 →	WH
	256	275	30	18	SO-3130-256 →	WH
	416	430	30	18	SO-3130-416 →	WH
● BN ● MB ● WH						
3380 	128	151	28	25	SO-3380-128 →	BN
	160	189	28	25	SO-3380-160 →	BN
	224	260	33	25	SO-3380-224 →	BN
	320	358	33	25	SO-3380-320 →	BN
	Use with 19mm screws on 16mm board					
● BN						







Stefano Orlati Handles

Bow Handles

	Centre (mm)	Length (mm)	Height (mm)	Width (mm)	Item number	Finish
6329 	128	167	26	22	SO-6329-128	MB
	192	231	26	22	SO-6329-192	MB
	256	295	26	22	SO-6329-256	MB
	320	359	27	22	SO-6329-320	MB
	128	167	26	22	SO-6329-128	MBN
	192	231	26	22	SO-6329-192	MBN
	256	295	26	22	SO-6329-256	MBN
	320	359	27	22	SO-6329-320	MBN
<p>● MB ● MBN</p>						
7025 	128	138	25	20	SO-7025-128	BN
	160	170	28	20	SO-7025-160	BN
	224	234	28	20	SO-7025-224	BN
	320	330	28	20	SO-7025-320	BN
<p>● BN</p>						
7039 	128	160	25	22	608.8H20.128.003	BN
	160	190	25	22	608.8H20.160.003	BN
	256	286	25	22	608.8H20.256.003	BN
	320	350	25	22	608.8H20.320.003	BN
<p>● BN</p>						
<p>*Available only in AU</p>						









Stefano Orlati Handles

Bow Handles

	Centre (mm)	Length (mm)	Height (mm)	Width (mm)	Item number	Finish
7090 	96	138	36	16	608.8F17.096.003	BN
	128	168	36	16	608.8F17.128.003	BN
	160	200	36	16	608.8F17.160.003	BN
	256	296	36	16	608.8F17.256.003	BN
	320	360	36	16	608.8F17.320.003	BN
 BN *Available only in AU						
7127 	128	148	29	10	608.8F16.128.003	BN
	160	180	29	10	608.8F16.160.003	BN
	256	276	29	10	608.8F16.256.003	BN
	320	349	29	10	608.8F16.320.003	BN
 BN *Available only in AU						
7165 	96	136	25	25	608.8H18.096.003	BN
	128	168	25	25	608.8H18.128.003	BN
	160	200	25	25	608.8H18.160.003	BN
	256	296	25	25	608.8H18.256.003	BN
 BN *Available only in AU						



Stefano Orlati Handles

Bow Handles

	Centre (mm)	Length (mm)	Height (mm)	Width (mm)	Item number	Finish
7179 	96	124	24	19	608.8F18.096.003	BN
	128	157	27	19	608.8F18.128.003	BN
	160	189	28	19	608.8F18.160.003	BN
	256	286	30	19	608.8F18.256.003	BN
 BN *Available only in AU						
DANES 7206 	128	138	14	25	SO-7206-128 →	MB
	160	170	14	25	SO-7206-160 →	MB
	256	266	14	25	SO-7206-256 →	MB
	320	330	14	25	SO-7206-320 →	MB
	128	138	14	25	SO-7206-128 →	PA
	160	170	14	25	SO-7206-160 →	PA
	256	266	14	25	SO-7206-256 →	PA
	320	330	14	25	SO-7206-320 →	PA
 MB  PA 						
7229 	128	170	32	12	608.8H21.128.003	BN
	160	202	34	12	608.8H21.160.003	BN
	320	362	32	12	608.8H21.320.003	BN
 BN *Available only in AU						



Stefano Orlati Handles

Bow Handles

	Centre (mm)	Length (mm)	Height (mm)	Width (mm)	Item number	Finish	
7232  ● BN *Available only in AU	128	165	28	12	608.8H19.128.003	BN	
	160	197	29	12	608.8H19.160.003	BN	
	320	344	32	12	608.8H19.320.003	BN	
7236  ● BN *Available only in AU	128	248	25	16	608.8O20.128.003	BN	
	160	272	25	16	608.8O20.160.003	BN	
	320	410	25	16	608.8O20.320.003	BN	
BELA 7530  ● MB ● TG	16	42	24	28	SO-7530-16 →	MB	
	64	100	24	20	SO-7530-64 →	MB	
	96	132	24	20	SO-7530-96 →	MB	
	128	164	24	20	SO-7530-128 →	MB	
	224	268	24	20	SO-7530-224 →	MB	
	16	42	24	20	SO-7530-16 →	TG	
	64	100	24	20	SO-7530-64 →	TG	
	96	132	24	20	SO-7530-96 →	TG	
	128	164	24	20	SO-7530-128 →	TG	
	224	268	24	20	SO-7530-224 →	TG	
	<i>Aura</i>						

Stefano Orlati Handles

Bow Handles

	Centre (mm)	Length (mm)	Height (mm)	Width (mm)	Item number	Finish
9908  ● BN ● CH	96	105	30	13	SO-9908-96 →	BN
	128	147	30	14	SO-9908-128 →	BN
	96	105	30	13	SO-9908-96 →	CH
	128	147	30	14	SO-9908-128 →	CH
• Use 19mm handle screws with 16mm board only						
9910  ● BN	96	114	21	10	SO-9910-96 →	BN
	128	150	27	12	SO-9910-128 →	BN
C  ● BN ● FS ● MB	128	148	26	10	SO-C-128 →	BN
	160	180	26	10	SO-C-160 →	BN
	192	212	26	10	SO-C-192 →	BN
	128	148	26	10	SO-C-128 →	FS
	160	180	26	10	SO-C-160 →	FS
	192	212	26	10	SO-C-192 →	FS
	128	148	26	10	SO-C-128 →	MB
	160	180	26	10	SO-C-160 →	MB
	192	212	26	10	SO-C-192 →	MB
Use 19mm screws on 16mm board						

Profile Handles



Stefano Orlati Handles

Profile Handles

- Create handleless openings for doors and top drawers
- Horizontal mounting
- Available in six on-trend finishes

CAPRI-J

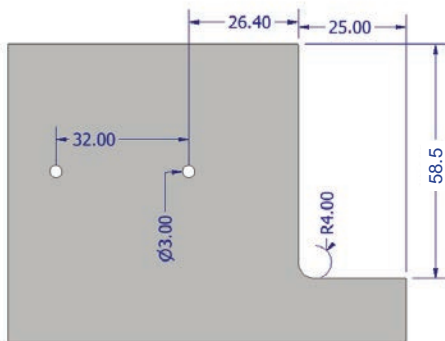
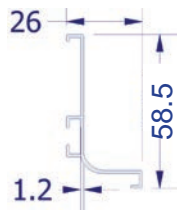

Length (mm)	Height (mm)	Depth (mm)	Item number	Finish
3600	58.5	26	608.8U10.360.001	FS
3600	58.5	26	608.8U10.360.007	CH
3600	58.5	26	608.8U10.360.010	MB
3600	58.5	26	608.8U10.360.011	MW
3600	58.5	26	608.8U10.360.013	TG
3000	58.5	26	608.8U10.360.015	G

· End caps and brackets ordered separately

Quoted dimensions consider that the CAPRI profile will have a 1mm overhang. Increase measurements by 1mm for applications where the CAPRI profile should be flush with the cabinet sides.

Stefano Orlati Handles

Profile Handles



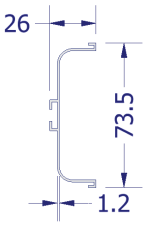
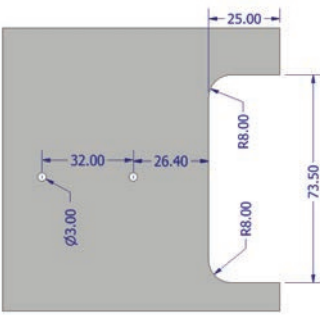

- Create handleless openings for drawers
- Horizontal mounting

	Length (mm)	Height (mm)	Depth (mm)	Item number	Finish
CAPRI-C   	3600	73.5	26	608.8U08.360.001	FS
	3600	73.5	26	608.8U08.360.007	CH
	3600	73.5	26	608.8U08.360.010	MB
	3600	73.5	26	608.8U08.360.011	MW
	3600	73.5	26	608.8U08.360.013	TG
	3000	73.5	26	608.8U08.360.015	G
	<ul style="list-style-type: none"> · Available in six on-trend finishes · End caps and brackets ordered separately 				
<p>Quoted dimensions consider that the CAPRI profile will have a 1mm overhang. Increase measurements by 1mm for applications where the CAPRI profile should be flush with the cabinet sides.</p>					

- FS ● CH ● MB
- MW ● TG ● G

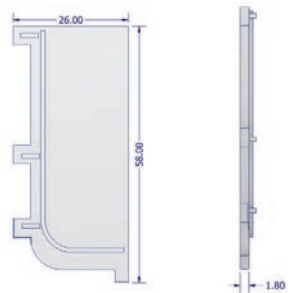
Stefano Orlati Handles

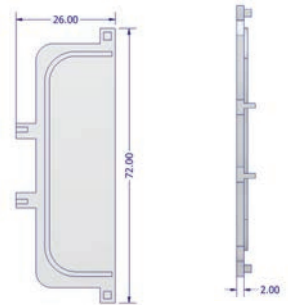
Profile Handles

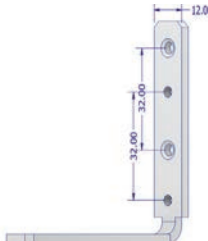
		Handing	Item number	Finish
CAPRI-J End Caps				
				
<ul style="list-style-type: none"> ● FS ● CH ● MB ○ MW ● TG ● G 		Left	608.8U17.056.001	FS
		Right	608.8U17.057.001	FS
		Left	608.8U17.056.007	CH
		Right	608.8U17.057.007	CH
		Left	608.8U17.056.010	MB
		Right	608.8U17.057.010	MB
		Left	608.8U17.056.011	MW
		Right	608.8U17.057.011	MW
		Left	608.8U17.056.013	TG
		Right	608.8U17.057.013	TG
		Left	608.8U17.056.015	G
		Right	608.8U17.057.015	G
CAPRI-C End Caps				
				
<ul style="list-style-type: none"> ● FS ● CH ● MB ○ MW ● TG ● G 		Universal	608.8U17.073.001	FS
		Universal	608.8U17.073.007	CH
		Universal	608.8U17.073.010	MB
		Universal	608.8U17.073.011	MW
		Universal	608.8U17.073.013	TG
		Universal	608.8U17.073.015	G
CAPRI Profile Mounting Bracket				
				
		Universal	608.8U19.070.001	
		<ul style="list-style-type: none"> · Universal mounting bracket for CAPRI Profile range · Simple 3 step mounting process 		

Stefano Orlati Handles

Profile Handles

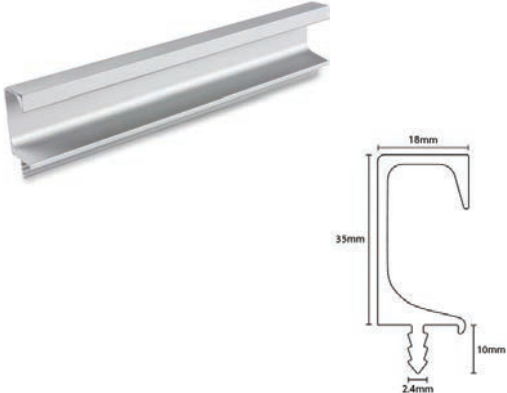
	Centre (mm)	Length (mm)	Height (mm)	Width (mm)	Item number	Finish
548 	128	170	26	17	SO-548-128 →	MB
	192	235	26	17	SO-548-192 →	MB
	128	170	26	17	SO-548-128 →	ABS
	192	235	26	17	SO-548-192 →	ABS
AK0891 	3000	30	16	SO-AK0891 →	FS	

● MB ● ABS

● FS

*Available only in NZ

Stefano Orlati Handles

Profile Handles

VODA 2163







- BC ● SB ● BA
- BN ● MB ○ MW

Aura

Centre (mm)	Length (mm)	Height (mm)	Width (mm)	Item number	Finish
25	40	18	45	SO-2163-40 →	BA
80	100	18	45	SO-2163-100 →	BA
160	200	18	45	SO-2163-200 →	BA
2x 128	300	18	45	SO-2163-300 →	BA
2x 160	350	18	45	SO-2163-350 →	BA
25	40	18	45	SO-2163-40 →	BC
80	100	18	45	SO-2163-100 →	BC
160	200	18	45	SO-2163-200 →	BC
2x 128	300	18	45	SO-2163-300 →	BC
2x 160	350	18	45	SO-2163-350 →	BC
25	40	18	45	SO-2163-40 →	BN
80	100	18	45	SO-2163-100 →	BN
160	200	18	45	SO-2163-200 →	BN
2x 128	300	18	45	SO-2163-300 →	BN
2x 160	350	18	45	SO-2163-350 →	BN
25	40	18	45	SO-2163-40 →	MB
80	100	18	45	SO-2163-100 →	MB
160	200	18	45	SO-2163-200 →	MB
2x 128	300	18	45	SO-2163-300 →	MB
2x 160	350	18	45	SO-2163-350 →	MB
25	40	18	45	SO-2163-40 →	MW
80	100	18	45	SO-2163-100 →	MW
160	200	18	45	SO-2163-200 →	MW
2x 128	300	18	45	SO-2163-300 →	MW
2x 160	350	18	45	SO-2163-350 →	MW
25	40	18	45	SO-2163-40 →	SB
80	100	18	45	SO-2163-100 →	SB
160	200	18	45	SO-2163-200 →	SB
2x 128	300	18	45	SO-2163-300 →	SB
2x 160	350	18	45	SO-2163-350 →	SB

Stefano Orlati Handles

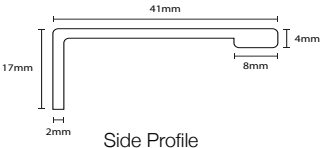
Profile Handles

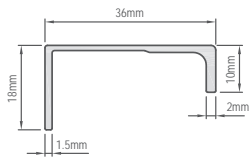
	Centre (mm)	Length (mm)	Height (mm)	Width (mm)	Item number	Finish	
7130  ● BN ● MB	20	40	25	35	608.8C17.020.010	MB	
	80	100	25	35	608.8C17.080.010	MB	
	160	180	25	35	608.8C17.160.010	MB	
	260	280	25	35	608.8C17.260.010	MB	
	20	40	25	35	608.8C17.020.003	BN	
	80	100	25	35	608.8C17.080.003	BN	
	160	180	25	35	608.8C17.160.003	BN	
	260	280	25	35	608.8C17.260.003	BN	
	*Available only in AU						
	R156  ● ABS  Side Profile	64	90	17	41	SO-R156-64 →	ABS
160		190	17	41	SO-R156-160 →	ABS	
· Mounts on top of panel edge							
PESARO PULL  ● ABS  Side Profile	200	18	36	SO-PP-200 →	ABS		
	2 screw holes - 40mm from edge						
	400	18	36	SO-PP-400 →	ABS		
	3 screw holes - 100mm between each hole & edge						
1250	18	26	SO-PP-1250 →	ABS			
Without holes drilled							
· Mounts on top of panel edge							

Provincial Handles









Stefano Orlati Handles

Provincial Handles

	Centre (mm)	Length (mm)	Height (mm)	Width (mm)	Item number	Finish
1186  ● BSAT ● BSBN	96	132	29	14	SO-1186-96 →	BSAT
	160	204	29	16	SO-1186-160 →	BSAT
	96	132	29	14	SO-1186-96 →	BSBN
	160	204	29	16	SO-1186-160 →	BSBN
	Complimentary knob 1186K page → 52					
1208  ● BSAT ● BSBN	96	135	31	34	SO-1208-96 →	BSAT
	96	135	31	34	SO-1208-96 →	BSBN
	Complimentary knob 1186K page → 52					
3440  ● MB ● BN ● BSBN	128	150	33	18	SO-3440-128 →	MB
	160	182	33	18	SO-3440-160 →	MB
	224	246	33	18	SO-3440-224 →	MB
	320	342	33	18	SO-3440-320 →	MB
	128	150	33	18	SO-3440-128 →	BN
	160	182	33	18	SO-3440-160 →	BN
	224	246	33	18	SO-3440-224 →	BN
	320	342	33	18	SO-3440-320 →	BN
	128	150	33	18	SO-3440-128 →	BSBN
	160	182	33	18	SO-3440-160 →	BSBN
	224	246	33	18	SO-3440-224 →	BSBN
	320	342	33	18	SO-3440-320 →	BSBN
	Complimentary knob 3440K page → 53					

Stefano Orlati Handles

Provincial Handles

	Centre (mm)	Length (mm)	Height (mm)	Width (mm)	Item number	Finish
6212 	128	144	34	16	SO-6212-128 →	BN
	160	177	34	16	SO-6212-160 →	BN
	256	274	34	16	SO-6212-256 →	BN
	128	144	34	16	SO-6212-128 →	CH
	160	177	34	16	SO-6212-160 →	CH
	256	274	34	16	SO-6212-256 →	CH
	128	144	34	16	SO-6212-128 →	MB
	160	177	34	16	SO-6212-160 →	MB
	256	274	34	16	SO-6212-256 →	MB
						
8391 	160	180	32	49	SO-8391-160 →	P
	Complementary knob 3801 page → 53 Complementary knob 8393 page → 54					
						
8392 	128	188	28	21	SO-8392-128 →	P
	Complementary knob 3801 page → 53 Complementary knob 8393 page → 54					
						

Stefano Orlati Handles

Provincial Handles

	Centre (mm)	Length (mm)	Height (mm)	Width (mm)	Item number	Finish
8407  ● CH ● MB ● AB ● BN	64	90	23	34	SO-8407-64 →	AB
	64	90	23	34	SO-8407-64 →	BN
	64	90	23	34	SO-8407-64 →	CH
	64	90	23	34	SO-8407-64 →	MB
	Complementary knob 8741 page → 55					
8658  ● CH ● MB ● AB ● BN	96	132	25	16	SO-8658-96 →	AB
	96	132	25	16	SO-8658-96 →	BN
	96	132	25	16	SO-8658-96 →	CH
	96	132	25	16	SO-8658-96 →	MB
	Complementary knob 8741 page → 55					
C15  ● WHC/P	128	150	40	23	SO-C15-128 →	WHC/P
	Complementary knobs C10 and C14 page → 55 & 56					

Recessed Handles



Stefano Orlati Handles

Recessed Handles

	Centre (mm)	Length (mm)	Height (mm)	Width (mm)	Item number	Finish
709  ● s	128	138	13	30	SO-709-128 →	S
	Suits minimum 16mm board Recess depth 10mm					
1102 Sliding Door Handle  	160	180	14	40	SO-1102-160 →	MB
	160	180	14	40	SO-1102-160 →	BN
	160	180	14	40	SO-1102-160 →	PG
	160	180	14	40	SO-1102-160 →	CH
	160	180	14	40	SO-1102-160 →	MC
	Ideal for use with OptiBoard sliding doors Recess depth 12mm Use 14mm screws on 16mm board Use 16mm screws on 19mm board					
● BN ● MB ● PG ● CH ● MC						

Square Handles



Stefano Orlati Handles

Square Handles

	Centre (mm)	Length (mm)	Height (mm)	Width (mm)	Item number	Finish
116  ● BN	128	159	29	15	SO-116-128 →	BN
	160	190	29	15	SO-116-160 →	BN
SVETLO 170  ● MB <i>Aura</i>	128	138	28	18	SO-170-128 →	MB
	160	170	28	18	SO-170-160 →	MB
	192	202	29	18	SO-170-192 →	MB
288  ● BN	128	141	36	16	SO-288-128 →	BN
	160	173	36	16	SO-288-160 →	BN
	224	237	36	16	SO-288-224 →	BN
	288	301	36	16	SO-288-288 →	BN

Stefano Orlati Handles

Square Handles

305



- AC
- BN ● AI

MALI 422



- BN ● MB ● TG

Aura

Centre (mm)	Length (mm)	Height (mm)	Width (mm)	Item number	Finish
128	145	25	12	SO-305-128 →	AC
160	177	25	12	SO-305-160 →	AC
224	241	27	12	SO-305-224 →	AC
320	337	27	12	SO-305-320 →	AC
128	145	25	12	SO-305-128 →	AI
160	177	25	12	SO-305-160 →	AI
224	241	27	12	SO-305-224 →	AI
320	337	27	12	SO-305-320 →	AI
128	145	25	12	SO-305-128 →	BN
160	177	25	12	SO-305-160 →	BN
224	241	27	12	SO-305-224 →	BN
320	337	27	12	SO-305-320 →	BN
64	76	30	18	SO-422-64 →	BN
160	173	30	18	SO-422-160 →	BN
320	333	30	18	SO-422-320 →	BN
64	76	30	18	SO-422-64 →	MB
160	173	30	18	SO-422-160 →	MB
320	333	30	18	SO-422-320 →	MB
64	76	30	18	SO-422-64 →	TG
160	173	30	18	SO-422-160 →	TG
320	333	30	18	SO-422-320 →	TG

Stefano Orlati Handles

Square Handles

	Centre (mm)	Length (mm)	Height (mm)	Width (mm)	Item number	Finish
CISTA 432  ● PA	64	120	32	23	SO-432-64 →	PA
	160	210	32	23	SO-432-160 →	PA
	320	355	32	23	SO-432-320 →	PA
<i>Aura</i>						
VELIK 454  ● PA ● MB ● PG ● MBN	160	168	40	16	SO-454-160 →	MB
	320	326	40	16	SO-454-320 →	MB
	160	168	40	16	SO-454-160 →	MBN
	320	326	40	16	SO-454-320 →	MBN
	160	168	40	16	SO-454-160 →	PA
	320	326	40	16	SO-454-320 →	PA
	160	168	40	16	SO-454-160 →	PG
	320	326	40	16	SO-454-320 →	PG
<i>Aura</i>						
VILA 663  ● CG ● MB ● TG	16	42	26	20	SO-663-16 →	CG
	128	157	37	18	SO-663-128 →	CG
	16	42	26	20	SO-663-16 →	MB
	128	157	37	18	SO-663-128 →	MB
	16	42	26	18	SO-663-16 →	TG
	128	42	37	20	SO-663-128 →	TG
<i>Aura</i>						

Stefano Orlati Handles

Square Handles

800



● SC ● PC

*Available only in AU

NARAVA 804



● MBN ● MB ● TG

Aura

Centre (mm)	Length (mm)	Height (mm)	Width (mm)	Item number	Finish
128	138	32	9.5	608.8M24.128.007	PC
160	170	32	9.5	608.8M24.160.007	PC
96	106	32	9.5	608.8M24.096.008	SC
128	138	32	9.5	608.8M24.128.008	SC
160	170	32	9.5	608.8M24.160.008	SC
K	25	25	22	SO-804-K →	MB
128	145	29	20	SO-804-128 →	MB
192	210	29	21	SO-804-192 →	MB
320	331	23	30	SO-804-320 →	MB
K	25	25	22	SO-804-K →	MBN
128	145	29	20	SO-804-128 →	MBN
192	210	29	21	SO-804-192 →	MBN
320	331	23	30	SO-804-320 →	MBN
K	25	25	22	SO-804-K →	TG
128	145	29	20	SO-804-128 →	TG
192	210	29	21	SO-804-192 →	TG
320	331	23	30	SO-804-320 →	TG

Stefano Orlati Handles

Square Handles

	Centre (mm)	Length (mm)	Height (mm)	Width (mm)	Item number	Finish
PRISTOP 815 	128	141	31	15	SO-815-128 →	MB
	192	205	31	15	SO-815-192 →	MB
	320	333	31	15	SO-815-320 →	MB
	128	141	31	15	SO-815-128 →	PA
	192	205	31	15	SO-815-192 →	PA
	320	333	31	15	SO-815-320 →	PA
	128	141	31	15	SO-815-128 →	SG
	192	205	31	15	SO-815-192 →	SG
	320	333	31	15	SO-815-320 →	SG
	<i>Aura</i>					
BARVA 1061 	160	168	27	13	SO-1061-160 →	MB
<i>Aura</i>						

● SG ● MB ● PA

● MB

Stefano Orlati Handles

Square Handles

1092





Centre (mm)	Length (mm)	Height (mm)	Width (mm)	Item number	Finish
96	102	27	11	SO-1092-96	MB
128	134	27	11	SO-1092-128	MB
160	166	27	11	SO-1092-160	MB
224	230	27	11	SO-1092-224	MB
288	294	27	11	SO-1092-288	MB
320	326	27	11	SO-1092-320	MB
96	102	27	11	SO-1092-96	BN
128	134	27	11	SO-1092-128	BN
160	166	27	11	SO-1092-160	BN
224	230	27	11	SO-1092-224	BN
288	294	27	11	SO-1092-288	BN
320	326	27	11	SO-1092-320	BN
96	102	27	11	SO-1092-96	CH
128	134	27	11	SO-1092-128	CH
160	166	27	11	SO-1092-160	CH
224	230	27	11	SO-1092-224	CH
288	294	27	11	SO-1092-288	CH
320	326	27	11	SO-1092-320	CH
96	102	27	11	SO-1092-96	MC
128	134	27	11	SO-1092-128	MC
160	166	27	11	SO-1092-160	MC
224	230	27	11	SO-1092-224	MC
288	294	27	11	SO-1092-288	MC
320	326	27	11	SO-1092-320	MC

- BN ● CH
- MB ● MC

Stefano Orlati Handles

Square Handles

	Centre (mm)	Length (mm)	Height (mm)	Width (mm)	Item number	Finish
VESELO 1399  ● MB <i>Aura</i>	160	193	37	10	SO-1399-160 →	MB
OKUS 1431  ● MB <i>Aura</i>	96	121	25	25	SO-1431-96 →	MB
	160	185	26	25	SO-1431-160 →	MB
	320	345	25	25	SO-1431-320 →	MB
1745  ● BN	128	137	28	21	SO-1745-128 →	BN
	192	201	28	21	SO-1745-192 →	BN
	256	265	28	21	SO-1745-256 →	BN

Stefano Orlati Handles

Square Handles

	Centre (mm)	Length (mm)	Height (mm)	Width (mm)	Item number	Finish
3061	128	158	25	20	SO-3061-128 →	MC
	192	226	27	24	SO-3061-192 →	MC
3064	128	157	27	8	SO-3064-128 →	SG
	160	192	27	8	SO-3064-160 →	SG
	320	355	27	8	SO-3064-320 →	SG
	96	121	27	8	SO-3064-96 →	MC
	128	157	27	8	SO-3064-128 →	MC
	160	192	27	8	SO-3064-160 →	MC
	192	224	27	8	SO-3064-192 →	MC
	240	273	27	8	SO-3064-240 →	MC
	320	355	27	8	SO-3064-320 →	MC
	128	157	27	8	SO-3064-128 →	MW
	160	192	27	8	SO-3064-160 →	MW
	320	355	27	8	SO-3064-320 →	MW
	96	121	27	8	SO-3064-96 →	BN
	128	157	27	8	SO-3064-128 →	BN
	160	192	27	8	SO-3064-160 →	BN
	192	224	27	8	SO-3064-192 →	BN
	240	273	27	8	SO-3064-240 →	BN
	320	355	27	8	SO-3064-320 →	BN

● MC

● MC
● SG ○ MW

*BN available only in NZ
Refer to Square Handle 3163 for equivalent BN and MB finishes

Stefano Orlati Handles

Square Handles

	Centre (mm)	Length (mm)	Height (mm)	Width (mm)	Item number	Finish	
3163 	96	121	25	8	608.8J18.096.010	MB	
	128	161	25	8	608.8J18.128.010	MB	
	160	193	25	8	608.8J18.160.010	MB	
	192	225	25	8	608.8J18.192.010	MB	
	240	273	25	8	608.8J18.240.010	MB	
	320	350	30	8	608.8J18.320.010	MB	
	96	121	25	8	608.8J18.096.003	BN	
	128	161	25	8	608.8J18.128.003	BN	
	160	193	25	8	608.8J18.160.003	BN	
	192	225	25	8	608.8J18.192.003	BN	
	240	273	25	8	608.8J18.240.003	BN	
	320	350	30	8	608.8J18.320.003	BN	
	<p>● BN ● MB *Available only in AU</p>						
	3447 	160	192	22	22	608.8O18.160.010	MB
128		158	20	22	608.8O18.128.003	BN	
160		192	22	22	608.8O18.160.003	BN	
192		226	25	22	608.8O18.192.003	BN	
<p>● BN ● MB *Available only in AU</p>							

Stefano Orlati Handles

Square Handles

4062







Centre (mm)	Length (mm)	Height (mm)	Width (mm)	Item number	Finish
96	104	28.3	8.3	SO-4062-96	MB
128	136	28.3	8.3	SO-4062-128	MB
160	168	28.3	8.3	SO-4062-160	MB
192	200	28.3	8.3	SO-4062-192	MB
256	264	28.3	8.3	SO-4062-256	MB
320	328	28.3	8.3	SO-4062-320	MB
416	424	28.3	8.3	SO-4062-416	MB
96	104	28.3	8.3	SO-4062-96	BN
128	136	28.3	8.3	SO-4062-128	BN
160	168	28.3	8.3	SO-4062-160	BN
192	200	28.3	8.3	SO-4062-192	BN
256	264	28.3	8.3	SO-4062-256	BN
320	328	28.3	8.3	SO-4062-320	BN
416	424	28.3	8.3	SO-4062-416	BN
96	104	28.3	8.3	SO-4062-96	TG
128	136	28.3	8.3	SO-4062-128	TG
160	168	28.3	8.3	SO-4062-160	TG
192	200	28.3	8.3	SO-4062-192	TG
256	264	28.3	8.3	SO-4062-256	TG
320	328	28.3	8.3	SO-4062-320	TG
416	424	28.3	8.3	SO-4062-416	TG

● BN ● MB ● TG

Stefano Orlati Handles

Square Handles

	Centre (mm)	Length (mm)	Height (mm)	Width (mm)	Item number	Finish
5012 	96	156	30	12	608.8D10.096.003	BN
	128	188	30	12	608.8D10.128.003	BN
	160	220	30	12	608.8D10.160.003	BN
	256	316	30	12	608.8D10.256.003	BN
	320	380	30	12	608.8D10.320.003	BN
 BN *Available only in AU						
5075 	128	142	22	14	SO-5075-128 →	MBN
	192	206	22	14	SO-5075-192 →	MBN
	320	334	22	14	SO-5075-320 →	MBN
	128	142	22	14	SO-5075-128 →	CH
	192	206	22	14	SO-5075-192 →	CH
	320	334	22	14	SO-5075-320 →	CH
	128	142	22	14	SO-5075-128 →	SB
	192	206	22	14	SO-5075-192 →	SB
	320	334	22	14	SO-5075-320 →	SB
	128	142	22	14	SO-5075-128 →	TG
	192	206	22	14	SO-5075-192 →	TG
	320	334	22	14	SO-5075-320 →	TG
						





Stefano Orlati Handles

Square Handles

	Centre (mm)	Length (mm)	Height (mm)	Width (mm)	Item number	Finish	
5076 	128	138	29	10	SO-5076-128 →	CH	
	192	202	29	10	SO-5076-192 →	CH	
	256	266	29	10	SO-5076-256 →	CH	
	320	330	29	10	SO-5076-320 →	CH	
	128	138	29	10	SO-5076-128 →	MB	
	192	202	29	10	SO-5076-192 →	MB	
	256	266	29	10	SO-5076-256 →	MB	
	320	330	29	10	SO-5076-320 →	MB	
	128	138	29	10	SO-5076-128 →	BN	
	192	202	29	10	SO-5076-192 →	BN	
	256	266	29	10	SO-5076-256 →	BN	
	320	330	29	10	SO-5076-320 →	BN	
							
7011 	96	102	26	12	608.8R16.096.007	PC	
	128	134	26	12	608.8R16.128.007	PC	
	160	166	26	12	608.8R16.160.007	PC	
	256	262	26	12	608.8R16.256.007	PC	
	96	102	26	12	608.8R16.096.003	BN	
	128	134	26	12	608.8R16.128.003	BN	
	160	166	26	12	608.8R16.160.003	BN	
	256	262	26	12	608.8R16.256.003	BN	
	320	326	26	12	608.8R16.320.003	BN	
							
	*Available only in AU						
	7120 	128	140	31	15	608.8A16.128.003	BN
160		172	31	15	608.8A16.160.003	BN	
256		268	31	15	608.8A16.256.003	BN	
							
*Available only in AU							

Stefano Orlati Handles

Square Handles

	Centre (mm)	Length (mm)	Height (mm)	Width (mm)	Item number	Finish
7128 	128	178	32	11	608.8B17.128.003	BN
	160	210	32	11	608.8B17.160.003	BN
	256	306	32	11	608.8B17.256.003	BN
	320	370	32	11	608.8B17.320.003	BN
 BN *Available only in AU						
7202 	128	144	28	12	608.8E18.128.010	MB
	160	176	28	12	608.8E18.160.010	MB
	256	272	28	12	608.8E18.256.010	MB
	320	337	28	12	608.8E18.320.010	MB
	128	144	28	12	608.8E18.128.016	BA
	160	176	28	12	608.8E18.160.016	BA
	256	272	28	12	608.8E18.256.016	BA
	320	337	28	12	608.8E18.320.016	BA
	96	111	28	12	608.8E18.096.003	BN
	128	144	28	12	608.8E18.128.003	BN
	160	176	28	12	608.8E18.160.003	BN
	256	272	28	12	608.8E18.256.003	BN
	320	337	28	12	608.8E18.320.003	BN
	128	144	28	12	608.8E18.128.017	SG
	160	176	28	12	608.8E18.160.017	SG
	256	272	28	12	608.8E18.256.017	SG
320	337	28	12	608.8E18.320.017	SG	
						

Stefano Orlati Handles

Square Handles

	Centre (mm)	Length (mm)	Height (mm)	Width (mm)	Item number	Finish
SIVA 7292 	128	155	31	22	SO-7292-128 →	Al
	192	220	31	22	SO-7292-192 →	Al
	224	255	31	22	SO-7292-224 →	Al
	128	155	31	22	SO-7292-128 →	TG
	192	220	31	22	SO-7292-192 →	TG
	224	255	31	22	SO-7292-224 →	TG
						
MEHKO 7298 	128	144	37	16	SO-7298-128 →	MB
	160	176	37	16	SO-7298-160 →	MB
	224	240	37	18	SO-7298-224 →	MB
	320	340	37	20	SO-7298-320 →	MB
	128	144	37	16	SO-7298-128 →	TG
	160	176	37	16	SO-7298-160 →	TG
	224	240	37	18	SO-7298-224 →	TG
	320	340	37	20	SO-7298-320 →	TG
						

● Al ● TG

MEHKO 7298

● MB ● TG

Stefano Orlati Handles

Square Handles

	Centre (mm)	Length (mm)	Height (mm)	Width (mm)	Item number	Finish
ROKA 7304 	K	68	33	17	SO-7304-K →	BN
	128	138	33	14	SO-7304-128 →	BN
	160	170	33	14	SO-7304-160 →	BN
	256	270	33	14	SO-7304-256 →	BN
	320	330	33	14	SO-7304-320 →	BN
	K	68	33	17	SO-7304-K →	MB
	128	138	33	14	SO-7304-128 →	MB
	160	170	33	14	SO-7304-160 →	MB
	256	270	33	14	SO-7304-256 →	MB
	320	330	33	14	SO-7304-320 →	MB
	K	68	33	17	SO-7304-K →	SG
	128	138	33	14	SO-7304-128 →	SG
	160	170	33	14	SO-7304-160 →	SG
	256	270	33	14	SO-7304-256 →	SG
	320	330	33	14	SO-7304-320 →	SG
VIDIK 7667 	96	115	19	32	SO-7667-96 →	MB
	128	146	19	32	SO-7667-128 →	MB
	192	210	19	32	SO-7667-192 →	MB
	96	115	19	32	SO-7667-96 →	SG
	128	146	19	32	SO-7667-128 →	SG
	192	210	19	32	SO-7667-192 →	SG
	96	115	19	32	SO-7667-96 →	TG
	128	146	19	32	SO-7667-128 →	TG
	192	210	19	32	SO-7667-192 →	TG

- MB
- BN ● SG

Aura

- MB
- TG ● SG

Aura

Stefano Orlati Handles

Square Handles

	Centre (mm)	Length (mm)	Height (mm)	Width (mm)	Item number	Finish
7092/08 	96	104	27	8	608.8B18.096.003	BN
	128	136	27	8	608.8B18.128.003	BN
	160	168	27	8	608.8B18.160.003	BN
	256	264	27	8	608.8B18.256.003	BN
	320	328	27	8	608.8B18.320.003	BN
 BN *Available only in AU						
7092/12 	96	106	30	12	608.8B19.096.003	BN
	128	138	30	12	608.8B19.128.003	BN
	160	170	30	12	608.8B19.160.003	BN
	256	266	30	12	608.8B19.256.003	BN
	320	330	30	12	608.8B19.320.003	BN
 BN *Available only in AU						

Stefano Orlati Handles

Square Handles

	Centre (mm)	Length (mm)	Height (mm)	Width (mm)	Item number	Finish
A 	128	135	30	12	SO-A-128 →	MB
	160	167	30	12	SO-A-160 →	MB
	224	231	30	12	SO-A-224 →	MB
	320	327	30	12	SO-A-320 →	MB
	128	135	30	12	SO-A-128 →	BN
	160	167	30	12	SO-A-160 →	BN
	224	231	30	12	SO-A-224 →	BN
	320	327	30	12	SO-A-320 →	BN
	128	135	30	12	SO-A-128 →	FS
	160	167	30	12	SO-A-160 →	FS
	224	231	30	12	SO-A-224 →	FS
	320	327	30	12	SO-A-320 →	FS
● BN ● MB ● FS						
B 	128	135	30	16	SO-B-128 →	MB
	160	167	30	16	SO-B-160 →	MB
	224	231	30	16	SO-B-224 →	MB
	320	327	30	16	SO-B-320 →	MB
	128	135	30	16	SO-B-128 →	BN
	160	167	30	16	SO-B-160 →	BN
	224	231	30	16	SO-B-224 →	BN
	320	327	30	16	SO-B-320 →	BN
	128	135	30	16	SO-B-128 →	FS
	160	167	30	16	SO-B-160 →	FS
	224	231	30	16	SO-B-224 →	FS
	320	327	30	16	SO-B-320 →	FS
● BN ● MB ● FS						

Stefano Orlati Handles

Square Handles

	Centre (mm)	Length (mm)	Height (mm)	Width (mm)	Item number	Finish
D	128	138	37	10	SO-D-128 →	MC
	96	106	37	10	SO-D-96 →	BN
	128	138	37	10	SO-D-128 →	BN
MH14	128	141	29	7	SO-MH14-128 →	S
	96	110	29	7	SO-MH14-96 →	BN
	128	141	29	7	SO-MH14-128 →	BN
	224	238	29	7	SO-MH14-224 →	BN
	96	110	29	7	SO-MH14-96 →	CH
	128	141	29	7	SO-MH14-128 →	CH
	224	238	29	7	SO-MH14-224 →	CH



● BN ● MC



● BN ● CH
● S

Stainless Steel Handles



Stefano Orlati Handles

Stainless Steel Handles

	Centre (mm)	Length (mm)	Height (mm)	Width (mm)	Item number	Finish
909  ● SS	128	142	40	14	SO-909-128 →	SS
	160	174	40	14	SO-909-160 →	SS
	224	238	40	14	SO-909-224 →	SS
	320	334	40	14	SO-909-320 →	SS
	480	494	40	14	SO-909-480 →	SS
6820  ● SS	128	136	31	21	SO-6820-128 →	SS
	160	168	31	21	SO-6820-160 →	SS
	224	232	31	21	SO-6820-224 →	SS
	320	328	31	21	SO-6820-320 →	SS
8513  ● SS	128	150	40	13	SO-8513-128 →	SS
	160	182	40	13	SO-8513-160 →	SS
	192	214	40	13	SO-8513-192 →	SS
	224	246	40	13	SO-8513-224 →	SS
	352	374	40	13	SO-8513-352 →	SS

Stefano Orlati Handles

Stainless Steel Handles

	Centre (mm)	Length (mm)	Height (mm)	Width (mm)	Item number	Finish
8721  ● SS	128	138	33	19	SO-8721-128 →	SS
	160	170	33	19	SO-8721-160 →	SS
	192	202	33	19	SO-8721-192 →	SS
	224	234	33	19	SO-8721-224 →	SS
	320	330	33	19	SO-8721-320 →	SS
	448	458	33	19	SO-8721-448 →	SS
ARC  ● SS	128	148	31	10	SO-ARC-128 →	SS
	160	185	31	10	SO-ARC-160 →	SS
	224	260	31	10	SO-ARC-224 →	SS
	288	336	31	10	SO-ARC-288 →	SS
SSD  ● SS	128	138	33	10	SO-SSD-128 →	SS
	160	170	33	10	SO-SSD-160 →	SS
	192	202	33	10	SO-SSD-192 →	SS
	288	298	33	10	SO-SSD-288 →	SS
	352	362	33	10	SO-SSD-352 →	SS
	448	458	33	10	SO-SSD-448 →	SS
SSTB  ● SS	96	136	34	12	SO-SSTB-96 →	SS
	128	168	34	12	SO-SSTB-128 →	SS
	160	200	34	12	SO-SSTB-160 →	SS
	192	232	34	12	SO-SSTB-192 →	SS
	288	328	34	12	SO-SSTB-288 →	SS

Knobs









Stefano Orlati Handles

Knobs

	Centre (mm)	Length (mm)	Height (mm)	Width (mm)	Item number	Finish
MODRA 278  ● BN ● MB ● TG	32	23	40	49	SO-278-32 →	BN
	32	23	40	49	SO-278-32 →	MB
	32	23	40	49	SO-278-32 →	TG
<i>Aura</i>						
TEMEN 415  ● BN ● MB ● TG ● CH	K	76	46	76	SO-415-K →	BN
	K	76	46	76	SO-415-K →	CH
	K	76	46	76	SO-415-K →	MB
	K	76	46	76	SO-415-K →	TG
<i>Aura</i>						
VELIK-R 454-R  ● MBN ● MB ● PA ● PG	K	40	40	40	SO-454R-K →	MB
	K	40	40	40	SO-454R-K →	MBN
	K	40	40	40	SO-454R-K →	PA
	K	40	40	40	SO-454R-K →	PG
<i>Aura</i>						
VELIK-T 454-T  ● MBN ● MB ● PA ● PG	K	40	37	14	SO-454T-K →	MB
	K	40	37	14	SO-454T-K →	MBN
	K	40	37	14	SO-454T-K →	PA
	K	40	37	14	SO-454T-K →	PG
<i>Aura</i>						

Stefano Orlati Handles

Knobs

	Centre (mm)	Length (mm)	Height (mm)	Width (mm)	Item number	Finish
POLT 592   ● MB ● CH ● MBN	K	40	40	40	SO-592-K →	CH
	K	40	40	40	SO-592-K →	MB
	K	40	40	40	SO-592-K →	MBN
PERON 699   ● BN ● MB ● TG	K	43	34	43	SO-699-K →	BN
	K	43	34	43	SO-699-K →	MB
	K	43	34	43	SO-699-K →	TG
1112   ● BN ● CH ● MC	16	25	27	21	SO-1112-16 →	BN
	16	25	27	21	SO-1112-16 →	CH
	16	25	27	21	SO-1112-16 →	MC





Stefano Orlati Handles

Knobs

	Centre (mm)	Length (mm)	Height (mm)	Width (mm)	Item number	Finish
1160L  ● BN ● MC	K		28	25	SO-1160L-K →	BN
	K		28	25	SO-1160L-K →	MC
1186K  ● BSAT ● BSBN	K	38	25	19	SO-1186-K →	BSAT
	K	38	25	19	SO-1186-K →	BSBN
Complementary handles 1208 page → 22 Complementary handles 1186 page → 22						
3318  ● CH	16	39	18	21	SO-3318-16 →	CH
KOTA 3538  ● BN ● MB ● TG ● CH <i>Aura</i>	K	76	35	76	SO-3538-K →	BN
	K	76	35	76	SO-3538-K →	CH
	K	76	35	76	SO-3538-K →	MB
	K	76	35	76	SO-3538-K →	TG

Stefano Orlati Handles

Knobs

	Centre (mm)	Length (mm)	Height (mm)	Width (mm)	Item number	Finish
3440K 	K	21	33	18	SO-3440-K →	BN
	K	21	33	18	SO-3440-K →	BSBN
	K	21	33	18	SO-3440-K →	MB
	Complementary handles 3440 page → 22					
<p>● MB ● BN ● BSBN</p>						
3801 	K	33	25	33	SO-3801-K →	AB
	K	33	25	33	SO-3801-K →	BN
	K	33	25	33	SO-3801-K →	CH
	K	33	25	33	SO-3801-K →	MB
	K	33	25	33	SO-3801-K →	P
	Complementary handles 3801 page → 22					
<p>● AB ● BN ● CH ● P ● MB</p>						
ZLATI 7301 	64	100	20	48	SO-7301-64 →	BA
	64	100	20	48	SO-7301-64 →	BC
	64	100	20	48	SO-7301-64 →	BN
	64	100	20	48	SO-7301-64 →	MB
	64	100	20	48	SO-7301-64 →	MW
	64	100	20	48	SO-7301-64 →	SB
	Complementary handles 7301 page → 22					
<p>● BA ● BN ● BC ● SB ● MB ● MW</p> 						

Stefano Orlati Handles

Knobs

	Centre (mm)	Length (mm)	Height (mm)	Width (mm)	Item number	Finish
DUHA 7580  ● MB ● TG ● MBN ● SG <i>Aura</i>	K	30	30	30	SO-7580-K →	MB
	K	30	30	30	SO-7580-K →	MBN
	K	30	30	30	SO-7580-K →	SG
	K	30	30	30	SO-7580-K →	TG
8047  ● BN ● MC	K	38	31	38	SO-8047-K →	BN
	K	38	31	38	SO-8047-K →	MC
8393  ● P	K	64	32	22	SO-8393-K →	P







Stefano Orlati Handles

Knobs

	Centre (mm)	Length (mm)	Height (mm)	Width (mm)	Item number	Finish
8741 	K	33	28	33	SO-8741-K →	AB
	K	33	28	33	SO-8741-K →	BN
	K	33	28	33	SO-8741-K →	CH
	Complementary handle 8658 page → 24 Complementary handle 8407 page → 24					
● BN ● CH ● AB						
9909 	K	45		45	SO-9909-K →	MB
● MB						
C10 	K	30	30	30	SO-C10-K →	WHC/P
	Complementary handles C15 page → 24					
● WHC/P						

Stefano Orlati Handles

Knobs

	Centre (mm)	Length (mm)	Height (mm)	Width (mm)	Item number	Finish
C14 	K	75	35	23	SO-C14-K →	WHC/P
	Complementary handles C15 page → 24					
 WHC/P						
CV30 	K		30	30	608.8K20.030.003	BN
	K		30	30	608.8K20.030.007	CH
	K		30	30	608.8K20.030.008	SC
 BN  CH  SC	*Available only in AU					

Push Open



Stefano Orlati Handles

Push to Open

	Centre (mm)	Length (mm)	Width (mm)	Item number	Finish
9010	32	80	16	608.8Z00.000.403	SC
					
· Suits 13mm - 18mm board thickness					

● SC

*Available only in AU

Stefano Orlati Handles

Push to Open

TEZKA Push Panel 9054



Centre (mm)	Length (mm)	Height (mm)	Width (mm)	Item number	Finish
30	35	75	5	SO-9054-30 →	BN
30	35	75	5	SO-9054-30 →	CH
30	35	75	5	SO-9054-30 →	MB
30	35	75	5	SO-9054-30 →	TG

● BN ● MB ● TG ● CH

Aura

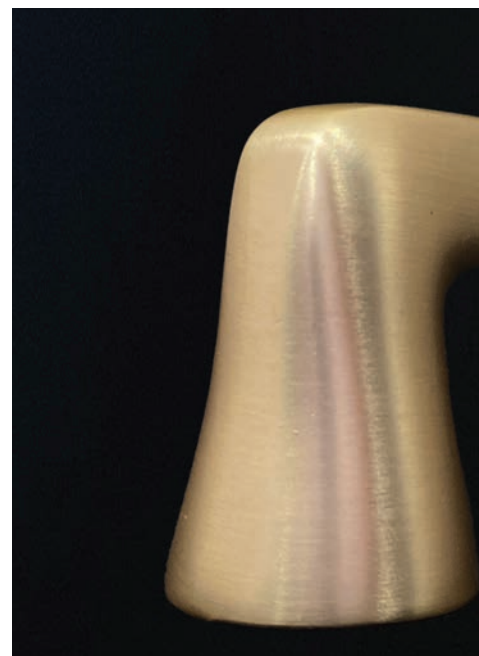



Worldwide design, manufacturing and distribution capabilities

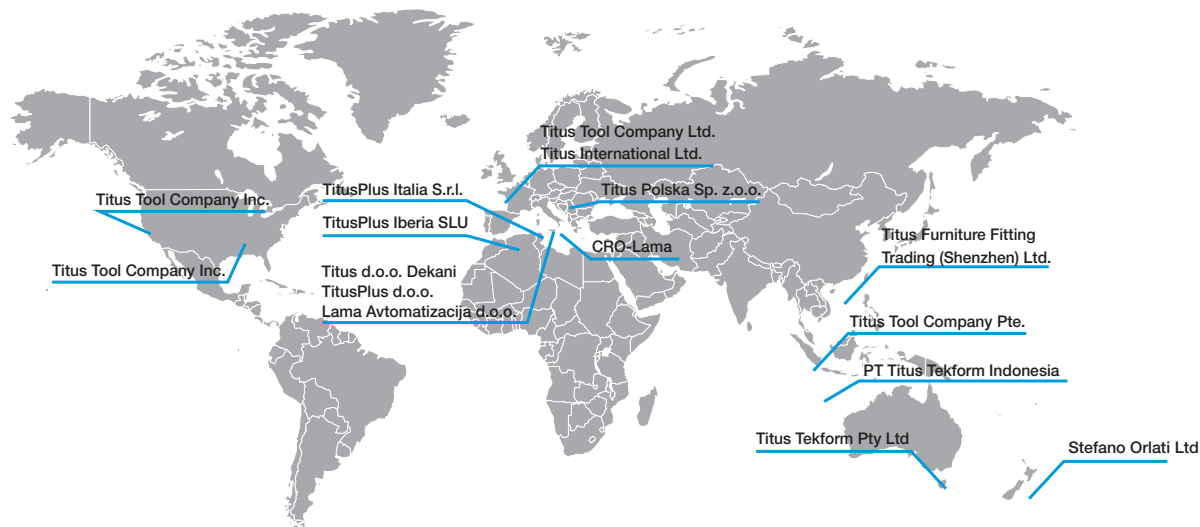

Australia

Victoria

Titus Tekform Pty Ltd
8/59 Jersey Road
Bayswater, VIC, 3153
T: +61 3 9737 5566
Fax: +61 3 9729 8780

Titus Tekform Pty Ltd
2/24 Kane Road
Wodonga, VIC, 3690
T: +61 2 6056 3188
Fax: +61 2 6056 3190

Western Australia

Titus Tekform Pty Ltd
5/2 Wittenberg Drive
Canning Vale, WA, 6155
T: +61 8 9455 2122
Fax: +61 8 9455 3680

South Australia

Titus Tekform Pty Ltd
PO Box 357,
Bayswater, VIC, 3153
T: +61 8 8447 3700
Fax: +61 8 8447 3183

Titus Group

Headquarters

Titus International Ltd
325 Euston Road
London
NW1 3AD, United Kingdom
info@titusplus.com

www.titusplus.com
info@titusplus.com

New South Wales

Titus Tekform Pty Ltd
83 Jedda Road
Prestons, NSW, 2170
T: +61 2 9826 0007
Fax: +61 2 9826 0074

Titus Tekform Pty Ltd
Unit 3, 100 Munibung Road
Cardiff, NSW, 2285
T: +61 2 4954 4011
Fax: +61 2 4354 4233

Titus Tekform Pty Ltd

Shop 6,
55 Heffernan Street
Mitchell, ACT, 2911
T: +61 2 9826 0007
Fax: +61 2 9826 0074

Tasmania

Titus Tekform Pty Ltd
88 Hopkins Street
Moonah, TAS, 7009
T: +61 3 6273 1199
Fax: +61 3 6273 0050

Australia

www.titustekform.com.au
info@titustekform.com.au

Queensland

Titus Tekform Pty Ltd
76 Northlink Place
Virginia, QLD, 4014
T: +61 7 3266 3999
Fax: +61 7 3266 5234

Titus Tekform Pty Ltd
Unit 1
719-725 Woolcock Street
Mt Louisa, QLD, 4814
T: +61 7 4779 1366
Fax: +61 7 4779 1316

New Zealand

Stefano Orlati Pty Ltd
337 Lincoln Road
Henderson, Auckland, 0610
T: +64 9 837 0886
Fax: +64 837 8003

Stefano Orlati Pty Ltd
162 Wordsworth Street
Sydenham, Christchurch, 8023
T: +64 3 981 8518
Fax: +64 3 942 7296

New Zealand

www.stefano-orlati.co.nz
stefano-orlati@titusplus.com



SCAN TO VIEW PRICING AND STOCK:



AUSTRALIA



NEW ZEALAND

Titus Tekform Australia

www.titustekform.com.au

info@titustekform.com.au

1300-0-TITUS

Stefano Orlati New Zealand

www.stefano-orlati.com

stefano-orlati@titusplus.com

Connect with us

Titus Tekform Titus+

Stefano Orlati Titus+

| *Aura*
Premium product range

