

fit giamo Kitchen Storage



Fit are proud to be a family-owned Kiwi firm and to lend our name to this range of great value for money kitchen storage solutions

These Fit Giamo units are comprehensively tested for durability and performance and, with correct installation and use, are backed by our lifetime guarantee.

View the full Fit Giamo range of innovative kitchen storage solutions on our website.

www.fit-nz.co.nz



Front cover photo courtesy of Sarah Smith, designer at Oakleigh Fine Furniture, Woolston, Christchurch
Joinery by Oakleigh Fine Furniture

Fit giamo Kitchen Storage



Tall Pantry Storage 4-7



Blind Corner Underbench Storage 10-13



L-Shaped Corner Underbench Storage 14-15



Pull Out Underbench Storage 18-22

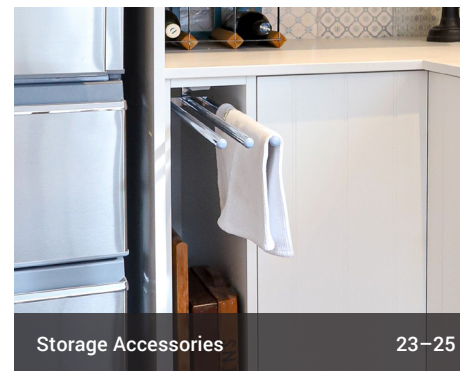

Storage Accessories 23-25



Undersink Storage 26-27

Welcome to Fit's Giamo Kitchen Storage catalogue

This catalogue includes detailed product information and many images of units in place to assist with your decision making process. We'd be delighted to answer any additional questions you may have.

For further information or to place an order, talk to your designer, kitchen maker, cabinet maker, or contact us directly via our website.

www.fit-nz.co.nz
info@fit-nz.co.nz
0800 852 258

Abbreviations

CAB... External cabinet width (with 16-19mm board)

MIN... Minimum

W..... Internal cabinet width

H..... Internal cabinet height

D..... Internal cabinet depth

 Denotes soft close function



Tall Pantry Storage

The familiar fixed front pull out pantry has many advantages including excellent access and visibility from both sides. Fit's option includes solid based or chromed wire baskets and several width and height variations. The only difficult thing about this one is choosing the model you want in your kitchen!

Fit Giamo Pull Out Pantries with Solid Base Baskets

- Full extension runners for excellent access to basket contents
- Soft close for easy and quiet closing
- Available to fit cabinet widths of 300mm, 400mm, 450mm and 500mm
- 3 height options, Short, Medium and Full Height, each with a good installation height range
- Solid base baskets; easy to clean and no drip-throughs
- Total load capacity: 100kg (including frame and cabinet front)
- Achievable Fit pantry minimum/maximum heights with 10mm tolerance are as follows: Short 1160-1570mm / Medium 1660-2070mm / Tall 1860-2270mm

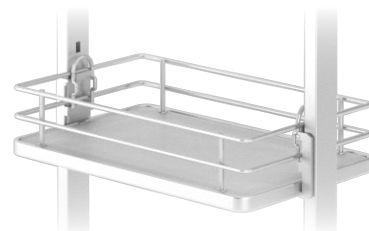

Item Code	Description	Cab	Min W	Min H	Min D
KUB30L.S	Tall Unit for Internal Cabinets 1860-2270mm, 6 Baskets	300	265	1860	495
KUB40L.S	Tall Unit for Internal Cabinets 1860-2270mm, 6 Baskets	400	365	1860	495
KUB45L.S	Tall Unit for Internal Cabinets 1860-2270mm, 6 Baskets	450	415	1860	495
KUB50L.S	Tall Unit for Internal Cabinets 1860-2270mm, 6 Baskets	500	470	1860	495
KTB30L.S	Medium Unit for Internal Cabinets 1660-2070mm, 5 Baskets	300	265	1660	495
KTB40L.S	Medium Unit for Internal Cabinets 1660-2070mm, 5 Baskets	400	365	1660	495
KTB45L.S	Medium Unit for Internal Cabinets 1660-2070mm, 5 Baskets	450	415	1660	495
KTB50L.S	Medium Unit for Internal Cabinets 1660-2070mm, 5 Baskets	500	470	1660	495
KSB30L.S	Short Unit for Internal Cabinets 1160-1570mm, 4 Baskets	300	265	1160	495
KSB40L.S	Short Unit for Internal Cabinets 1160-1570mm, 4 Baskets	400	365	1160	495
KSB45L.S	Short Unit for Internal Cabinets 1160-1570mm, 4 Baskets	450	415	1160	495
KSB50L.S	Short Unit for Internal Cabinets 1160-1570mm, 4 Baskets	500	470	1160	495
GIA101	Pantry Bracket Support for Extra Baskets (Pair)				

Full extension runners for excellent access to basket contents



Fit Giamo Pull Out Pantries with Chromed Wire Baskets

- Full extension runners for excellent access to basket contents
- Soft close for easy and quiet closing
- Available to fit cabinet widths of 300mm, 400mm, 450mm and 500mm
- 3 height options, Short, Medium and Full Height, each with a good installation height range
- Chromed wire baskets
- Total load capacity: 100kg (including frame and cabinet front)
- Achievable Fit pantry minimum/maximum heights with 10mm tolerance are as follows: Short 1160-1570mm / Medium 1660-2070mm / Tall 1860-2270mm

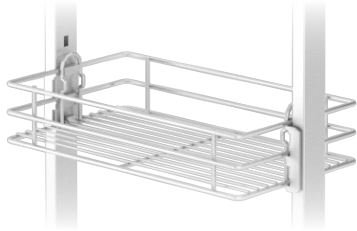

Item Code	Description	Cab	Min W	Min H	Min D
KUB30WC.S	Tall Unit for Internal Cabinets 1860-2270mm, 6 Baskets	300	265	1860	495
KUB40WC.S	Tall Unit for Internal Cabinets 1860-2270mm, 6 Baskets	400	365	1860	495
KUB45WC.S	Tall Unit for Internal Cabinets 1860-2270mm, 6 Baskets	450	415	1860	495
KUB50WC.S	Tall Unit for Internal Cabinets 1860-2270mm, 6 Baskets	500	470	1860	495
KTB30WC.S	Medium Unit for Internal Cabinets 1660-2070mm, 5 Baskets	300	265	1660	495
KTB40WC.S	Medium Unit for Internal Cabinets 1660-2070mm, 5 Baskets	400	365	1660	495
KTB45WC.S	Medium Unit for Internal Cabinets 1660-2070mm, 5 Baskets	450	415	1660	495
KTB50WC.S	Medium Unit for Internal Cabinets 1660-2070mm, 5 Baskets	500	470	1660	495
KSB30WC.S	Short Unit for Internal Cabinets 1160-1570mm, 4 Baskets	300	265	1160	495
KSB40WC.S	Short Unit for Internal Cabinets 1160-1570mm, 4 Baskets	400	365	1160	495
KSB45WC.S	Short Unit for Internal Cabinets 1160-1570mm, 4 Baskets	450	415	1160	495
KSB50WC.S	Short Unit for Internal Cabinets 1160-1570mm, 4 Baskets	500	470	1160	495
GIA101	Pantry Bracket Support for Extra Baskets (Pair)				



Soft close for easy and quiet closing



Photo courtesy of Sarah Smith, designer at Oakleigh Fine Furniture, Woolston, Christchurch
Joinery by Oakleigh Fine Furniture



Photo courtesy of the team at Hura Joinery Services, Hastings



Photo courtesy of Above Board Design & Cabinetry, Tauranga, and taken by Liam at Aftermarket Photography



Photo courtesy of Jessica, William, and the team at Creative Craftsmen, Rotorua

Corner Storage Solutions

Kitchen corner storage made easy with Fit. Whether you have one opening door or two, Fit helps you make the most of the space in those hard to reach kitchen cabinets. These well-priced, clever corner cabinet ideas include swing-out, revolving and “magic” corner units.

Fit Giamo Magic Corner Unit

- Rear baskets slide forward as door opens for easy access to all contents
- Clever design means one unit suits left or right hand opening units
- Very solid, hard working construction
- Choose from heavy-gauge nickel chrome-plated or solid base basket options
- Soft close feature with quality Austrian made Grass slides
- Load capacity: 5kg weight on each outer basket and 12kg on per inner basket
- Minimum door width: 400mm

Item Code	Description	Cab	Min W	Min H	Min D
KCB45WCL	Magic Corner Unit with Solid Base Baskets	900	860	590	485
KCB45WC	Magic Corner Unit with Chromed Wire Baskets	900	860	590	485

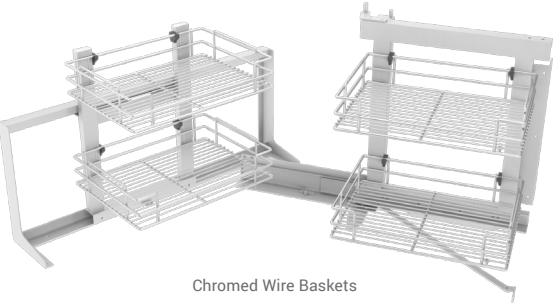
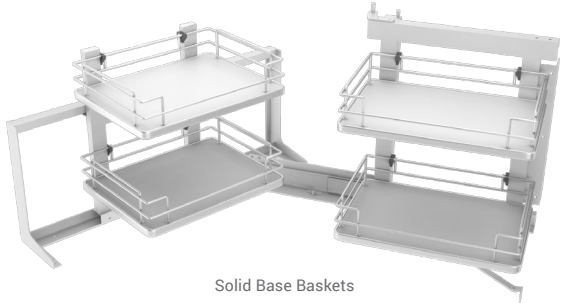

Clever design means one unit suits left or right hand opening



All photos courtesy of Ace Kitchens & Laminates, Upper Hutt

Fit Giamo Duplo Swinging Two Tier Unit

- A unique way of utilising those hard to access corner spaces
- Two specially shaped shelves glide out smoothly, providing large capacity, easy access storage
- Each shelf operates independently
- Soft close for easy and quiet use
- Easy wipe, solid base shelf surface
- Load capacity: 25kg per shelf, 50kg total for unit
- Suits 450mm door

Item Code	Description	Cab	Min W	Min H	Min D
DUP45R	Duplo Unit, Right Hand Opening	900	825	600-750	495
DUP45L	Duplo Unit, Left Hand Opening	900	825	600-750	495

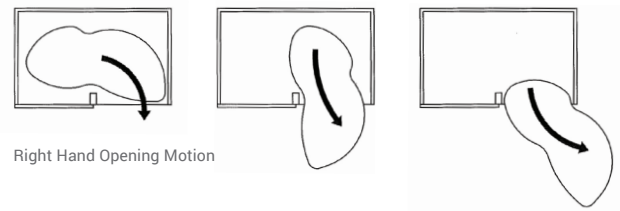
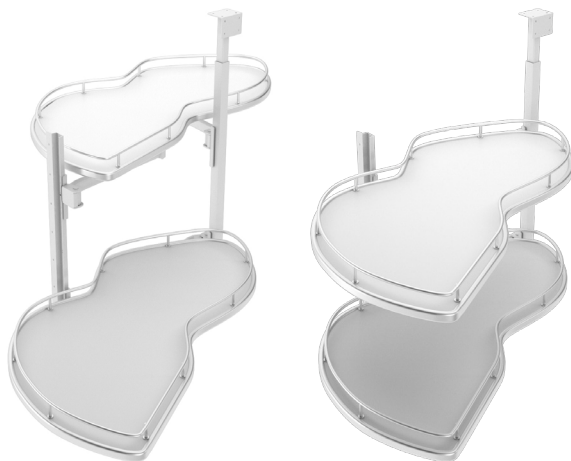

Easy wipe, solid base shelf surface

Photo courtesy of Sarah Smith, designer at Oakleigh Fine Furniture, Woolston, Christchurch
Joinery by Oakleigh Fine Furniture

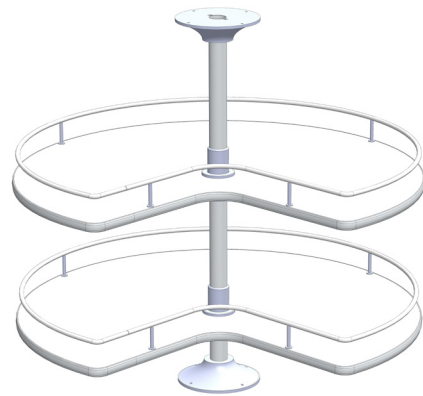

Photo courtesy of Highland Carpentry & Joinery, Taupo

Fit Giamo 270° Revolving Units with Solid Base Shelves

- 2 solid base 270° shelves with chromed rails
- Each shelf rotates independently with a locator so it stops in the correct position for closing doors
- 20kg carrying-capacity per shelf

Item Code	Description	Cab	Min W	Min H	Min D
GLS75.720SL	270° Revolving Unit, Chromed Wire, 720mm Diameter	800 x 800	750	680	750
GLS75.820SL	270° Revolving Unit, Chromed Wire, 820mm Diameter	900 x 900	750	680	840



Each shelf rotates independently with a locator to stop in correct position for closing doors



Above photos courtesy of Above Board Design & Cabinetry, Tauranga, and taken by Liam at Aftermarket Photography



Underbench Storage

Brilliant under bench storage for tight spaces in your kitchen. Fit's value for money, multi-purpose side-mounted pull-out units are perfect for under bench cabinets or base cabinets, and come with wire baskets or solid base baskets, and in 2-tier and 3-tier models. Soft close? Of course!

Fit Giamo Side Mounted Pull Out Unit with Solid Base Baskets

Excellent multi-purpose storage option for tight spaces

- Ideal for spices, bottles or other small goods
- Soft close for easy and quiet use
- Available to suit cabinet widths of 150mm, 200mm and 300mm
- 2 shelf and 3 shelf variants available for each cabinet width
- Solid base baskets
- Unit suitable for both left hand and right hand installation
- Add optional divider bars (ordered separately) to keep bottles and tall items steady and secure
- 25kg total carrying capacity, including shelf weight



Pull Out Units

Item Code	Description*	Cab	Min W	Min H	Min D
GSMR150.SL	2 Solid Base Baskets	150	110	615	495
GSMR200.SL	2 Solid Base Baskets	200	155	615	495
GSMR300.SL	2 Solid Base Baskets	300	255	615	495
GSMR300150.SL	2 Wire Baskets (1 full width, 1 half width)	300	255	615	495
GSMR150SLS.3	3 Solid Base Baskets	150	110	615	495
GSMR200SLS.3	3 Solid Base Baskets	200	155	615	495
GSMR300SLS.3	3 Solid Base Baskets	300	255	615	495

Divider Bars

Item Code	Description
GSMR150D	Divider Bar for 150mm Baskets
GSMR200D	Divider Bar for 200mm Baskets
GSMR300D	Divider Bar for 300mm Baskets

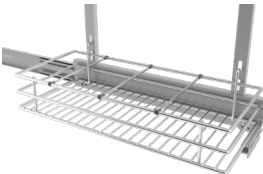

*Full width baskets unless otherwise stated in description



"The team at FIT are fantastic and bend over backwards to 'fit' your needs. Always great quality products and the service and communication is on point."

Ross Herriot
Highland Carpentry & Joinery
Taupo



Ideal as a laundry and cleaning supplies pull out too!

Photo courtesy of Oliver Wearmouth

Photo courtesy of The Kitchen Centre, Henderson, Auckland

Fit Giamo Side Mounted Pull Out Unit with Chromed Wire Baskets

Excellent multi-purpose storage option for tight spaces

- Ideal for spices, bottles or other small goods
- Soft close for easy and quiet use
- Available to suit cabinet widths of 150mm, 200mm and 300mm
- 2 shelf and 3 shelf variants available for each cabinet width
- Chromed wire baskets
- Unit suitable for both left hand and right hand installation
- Add optional divider bars (ordered separately) to keep bottles and tall items steady and secure
- 25kg total carrying capacity, including basket weight



Pull Out Units

Item Code	Description*	Cab	Min W	Min H	Min D
GSMR150.S	2 Wire Baskets	150	110	615	495
GSMR200.S	2 Wire Baskets	200	155	615	495
GSMR300.S	2 Wire Baskets	300	255	615	495
GSMR300150.S	2 Wire Baskets (1 full width, 1 half width)	300	255	615	495
GSMR150S.3	3 Wire Baskets	150	110	615	495
GSMR200S.3	3 Wire Baskets	200	155	615	495
GSMR300S.3	3 Wire Baskets	300	255	615	495

Divider Bars

Item Code	Description
GSMR150D	Divider Bar for 150mm Baskets
GSMR200D	Divider Bar for 200mm Baskets
GSMR300D	Divider Bar for 300mm Baskets

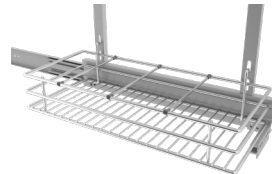

*Full width baskets unless otherwise stated in description



Fit Giamo Pull Out Baskets

A great, practical way to keep organised in kitchens, laundries, play rooms, craft areas and more!

- Full extension for easy access
- European made runners
- Load capacity: 40kg total on runners, including the basket weight
- Basket height: 120mm + 50mm for runners
- Basket depth: 485mm
- Minimum internal cabinet depth: 500mm
- Solid base with chromed wire rails
- Supplied with spacers to ensure basket clears hinged doors

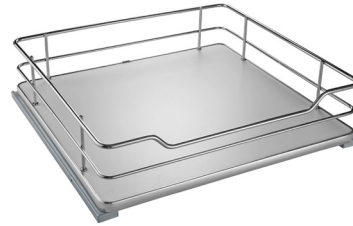

Item Code	Description	Cab	Min W	Min H	Min D
GDS045	Solid Base Pull Out Basket	450	418	170	500
GDS050	Solid Base Pull Out Basket	500	468	170	500
GDS060	Solid Base Pull Out Basket	600	568	170	500
GDS090	Solid Base Pull Out Basket	900	868	170	500

Fit Giamo Overhead Wine Glass Holders

Keep your wine glasses handy but safely out of the way of little hands

Item Code	Description	W	H	D
F09041.25	Overhead Wine Glass Holder, 1 Row	105	65	262
F09041	Overhead Wine Glass Holder, 1 Row	125	65	340
F09042	Overhead Wine Glass Holder, 2 Rows	215	65	340
F09044.25	Overhead Wine Glass Holder, 4 Rows	435	65	255
F09044	Overhead Wine Glass Holder, 4 Rows	435	65	340



Photo courtesy of Harrison's Kitchens, part of Harrison's.nz

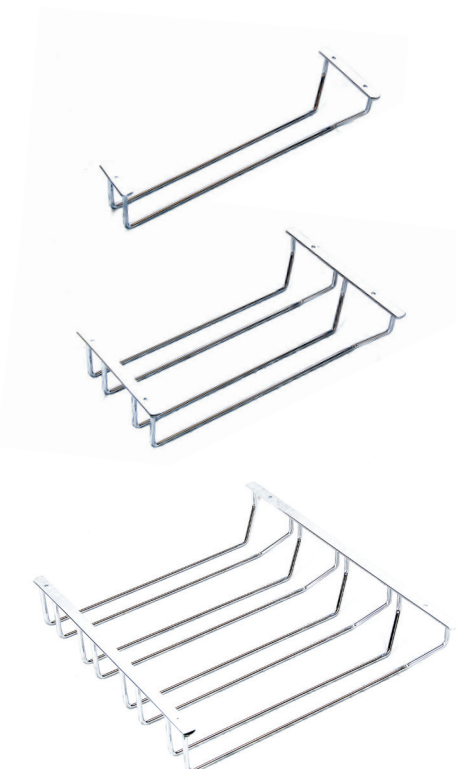

Fit Giamo Door Mounted Spice Racks

- Simply screw to the back of the door
- 3 sizes
- Chrome plated

Item Code	Description	Cab	Min W	Min H	Min D
DMSR30	Door Mounted Spice Rack	300	225	425	67
DMSR40	Door Mounted Spice Rack	400	325	425	67
DMSR45	Door Mounted Spice Rack	450	375	425	67



Fit Giamo Tea Towel Rails

Top Mounted Pull Out Rails

Item Code	Description	Min W	Min H	Min D
GATR2	Top Mount Pull Out Tea Towel Rail Aluminium, 2 Rail	66	75	460
GATR3	Top Mount Pull Out Tea Towel Rail Aluminium, 3 Rail (Vauth-Sagel)*	62	100	466



*May be side mounted; allow 140mm for width

Door Mounted Rails

Item Code	Description	Min W	Min D
GTSS.23	Door Mounted Tea Towel Rail, Stainless Steel	232	43
GTSS.32	Door Mounted Tea Towel Rail, Stainless Steel	328	43
GTSS.39	Door Mounted Tea Towel Rail, Stainless Steel	392	43
GTSS.48	Door Mounted Tea Towel Rail, Stainless Steel	488	43



Model GATR3

"We have been using FIT products for a number of years in our bespoke cabinetry. The products are great, the delivery efficient and the customer service is impeccable. Keep up the good work FIT."

**Royale Kitchens
Browns Bay, Auckland**



Model GATR2
Above and left photos courtesy of The Custom Space, Nelson

Fit Giamo Deluxe Detergent & Cleaner Pull Outs

- Removable basket makes it a breeze to carry cleaning supplies to the task
- Soft close slides for easy and quiet use
- Chrome plated wire or solid base basket options
- Suitable for both right hand and left hand installation
- Load capacity: 15kg

Item Code	Description	Min W	Min H	Min D
GDR0250W	Deluxe Detergent Pull Out Wire Basket	300	485	495
GDR0250L	Deluxe Detergent Pull Out Solid Base Basket	300	485	495

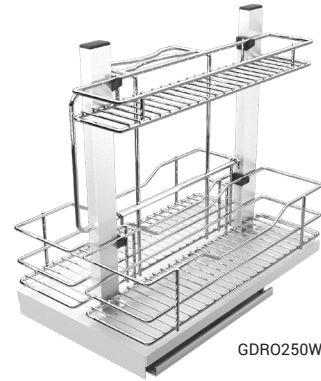

GDR0250W

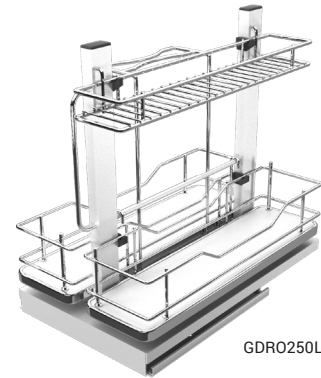

GDR0250L

Fit Giamo Detergent & Cleaner Pull Outs

- Universally handed
- Soft close
- Side spacers so it clears the hinges when pulled out
- 15kg carrying-capacity
- Available as chromed wire model and in solid base model

Item Code	Description	Min W	Min H	Min D
GSRO200.CP	Stainless Steel Detergent Rack Chromed Wire	260	390	495
GSRO200.SL	Stainless Steel Detergent Rack Solid Base	260	390	495

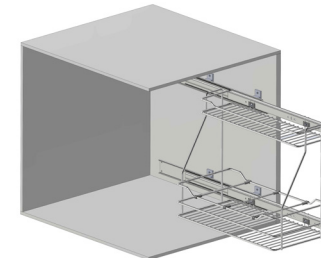

GSRO200.CP



Model GSRO200.SL

"FIT products match that of top brands with quality and functionality at a much more competitive rate and they come with a warranty. Try them, you will not be disappointed."

**Bremich Cabinetmakers
Swanson, Auckland**



Model GDR0250L
Photo courtesy of Duncan Joinery

“Need some reassurance about Fit’s service and product quality? You don’t need to take our word for it!”

“We have been using FIT products in our custom-made kitchens for many years. The products are of high quality, and we always receive excellent customer service from the FIT team. We would have no hesitation in recommending their products.”

Kiwi Kitchens, Christchurch

“FIT staff are always friendly, knowledgeable, and willing to help. They provide a great range of products at competitive prices. They stand by their products and follow up with great customer service, ongoing support and regular information and product updates that I can share with my clients.”

Karen Warner, Perfect Order Kitchen Design, Wellington

“FIT, you guys have been amazing! Your product arrives to us quickly and well packaged. And if we ever need any help our rep is fantastic to deal with. We very rarely have trouble getting stock. And if we do the communication is really good. 10/10.”

Rebecca, Handcraft Kitchens & Joinery, Opawa, Christchurch

“I love dealing with FIT and would encourage anyone who hasn’t tried them already to give them a go. They have a huge range of products at a good price and have prompt delivery. We never have any issues with the products and will continue to use them in our joinery. We couldn’t be happier with the relationship we have with FIT.”

Jennings Joinery, Christchurch

“FIT have always provided our company with excellent service. Their sales agents are knowledgeable and always respond to any questions quickly. Our company always spec FIT products before others. They offer value and service. We look forward to maintaining our working relationship for the years to come.”

Hunter Anderson Architecture, Christchurch

“I’ve used FIT for many years now. It’s always great service, but the best measure of how good a business is is how they react when there’s an issue or problem. On the rare occasion we’ve had one, it’s been sorted out immediately. There are no excuses or blame, just a fix.”

The Villa Wardrobe Company, Helensville, Auckland

“Well run and supportive business that takes pride in focusing on relationships. Communication prompt and clear, and always a can-do team!”

State of Ply, Mount Maunganui

“What a fabulous company to deal with, great range of top quality products and constantly keeping ahead of the game.”

Tony Cooper, Cooper Furniture & Joinery, Stokes Valley, Lower Hutt

“FIT are very easy to deal with. Their sales people are well trained in all their products and helpful in finding the right product for our needs. A great range of products.”

Andy Sowden, Homeowner, Auckland

“FIT is a fundamental supplier to our business. Their products are very high quality and offer great solutions for our needs. Their service is second to none.”

Matakana Kitchens & Joinery

“Great company ethics. Great staff and management. Great products backed up by a great service. You couldn’t ask for more.”

George Hurren, Personalised Kitchens & Joinery, Picton

“I have been using FIT products for all of my career and I just love them. Easy to spec and install. Great customer service throughout the process and really innovative with coming up with new and interesting products to make clients’ lives easier.”

Sophie McDougall-Wenn, Stella Design Co, Whanganui

“The service that I have received from your company, when I had a small issue with one of my kitchen drawers, was par excellence. The response was prompt and the information given expert and effective.”

Ian Rainey, Homeowner, Auckland

“Great Service. Great Products. Great Delivery Times. One of the best suppliers out there.”

Dream Doors, North Shore, Auckland

“We have been using Fit for many years now. The customer service is the best in the industry. All of the Fit team have a passion for the product. They will go the extra mile to make sure we, the client, are getting the products we need when we need them.”

Brendon Dunn, Contrast Interiors, Henderson, Auckland





ENHANCING LIVING
SPACES TOGETHER

Office and Distribution

22 Hood Street
Wellsford 0900
0800 852 258
info@fit-nz.co.nz
www.fit-nz.co.nz

Christchurch Distribution and Showroom

4 Morse Road
Wigram
Christchurch 8042



Fit NZ



fitnzhomestorage



fitnzhomestorage



FitNewZealand



houzz

