

Since 1982

TRAD_{CO}

Defining the Details



Contents

Our History	3	Home Fixtures & Fittings	99
Selecting Your TradCo Hardware	5	Traditional Bathroom Accessories	100
Unlacquered Finishes	17	Hat & Coat Hooks	101
Door Furniture	19	Robe Hooks	104
Door Levers	20	Picture Rail Hooks	106
Iron Levers	27	Curtain Fittings	106
Door Knobs • Sheet Brass	29	Brackets	108
Door Knobs	34	Cabin Hooks	109
Centre Door Knobs	37	Iron Gate Accessories	110
Door Knockers	39	Numerals	111
Pull Handles	41	Letter Plates	111
Push Plates	46	Door Bells	111
Flush Pulls	46	Screws & Tie Bolts	114
Door Stops	48	Light Switches & Sockets	117
Locks, Latches & Hinges	51	Period Switches & Sockets	118
Internal Locks	52	Switch & Socket Wood Blocks	120
External Locks	53	Flat Plate Switches & Sockets	122
Tube Latches & Privacy Turns	56	Cabinet Fittings	129
Escutcheons	58	Cupboard Knobs	130
Euro Cylinders	60	Drawer Pulls	136
Rim Locks & Accessories	61	Pull Handles	139
Screen Door Latches	62	Iron Pull Handles	140
French Door Fasteners	63	Traditional Cabinet Handles	140
Hinges	64	Kitchen Dresser Accessories	142
Window Fittings & Bolts	73	Catches, Locks & Hinges	142
Bolts	74	Trunk Accessories	144
Casement Window Stays	83	Castors	145
Quadrant Stays	86	Door Lock Technical Information	146
Casement Window Fasteners	87	Technical Information	147
Fanlight Window Fittings	91	Window Guide	148
Hopper Window Fittings	92	Glossary of Terms	152
Sash Window Fasteners	93	Index	154
Sash Window Lifts	95	Notes	158
Sash Window Pulleys & Drops	97		



Pictured: Circa 1986 – TradCo's first permanent wholesale premises. Magill Road, Norwood South Australia.

Our History

Humble Beginnings

The story of TradCo began nearly four decades ago when Graham and Denise Duff started producing restoration architectural hardware to sit neatly within Australia's historical homes. As the business grew, so did the range of designs. TradCo now offers over 4000 diverse products that stem from a range of design influences and are sold in over 600 stores across Australia and New Zealand.

Our Heart

TradCo was conceived in Adelaide, where its head office and central distribution point remains. This has enabled the business to retain its best employees, some of which have been with the company for close to 30 years. Staff from across the country and overseas have also joined the company, bringing with them experience which adds to the melting pot of ideas and innovations.

Trust

Our values, history and expertise have enabled TradCo to foster trusting, long term business relationships with our customers; understanding their unique requirements and providing convenient, timely solutions. If our people are the heart of our business, our strong service standard is what the company is built on.

Defining the Details

At TradCo we're driven by detail. You'll see it in each of our products. You'll see it in our stunning range of finishes. More importantly, you'll see and feel it each time you interact with one of our quality products within your space. We believe that when a house is finished with care it transforms— it becomes a home—a part of people's lives. We respect the history of every home, and love to restore old buildings to their former glory. Whether it be a hinge, light switch or door lever, every one of our products has been created with this in mind. These values allow us to define the details so that we can help enhance your home.

Quality You Can Feel

Nothing quite offers the strength, beauty and versatility of brass. We use high-quality brass, sand casting and forging methods to create products of unparalleled distinction, that are as durable as they are beautiful.



Selecting Your TradCo Hardware

At TradCo we believe that when a house is finished with care it transforms – it becomes a home – a part of people’s lives.

This hardware guide has been created to share our passion for design and to assist you to realise your design aspirations.

We know that selecting the right hardware for your home or project can be a daunting task, so we want to simplify that process.

By following each step in our hardware guide we’ll help you find the right styles, finishes and accessories to suit your home.

For further information and assistance please visit our website: tradco.com.au

Step 1 (Page 6)

Determine the architectural style of your home and select complementary door furniture

Step 2 (Page 9)

Select a finish to complement the colour scheme and style of your home

Step 3 (Page 12)

Determine whether your door needs a lock and choose the correct locking mechanism

Step 4 (Page 13)

Select the right hinges for your needs, available in a range of matching finishes

Step 5 (Page 14)

Select matching accessories to your selected door furniture

Step 1

Determine the architectural style of your home and select complementary door furniture:

Colonial



2005
Page 62



21371 UPB
Page 32

Federation/Edwardian



0854 AB
Page 30



0786 AB
Page 20

Queenslander



1025 PB
Page 22



1024 PB
Page 33

Art Deco



1090 CP
Page 30



0804 CP
Page 30

Victorian



0907 CP
Page 21



1040 CP
Page 35

Bungalow



1060 AC
Page 29



0728 AC
Page 34

Step 1

Determine the architectural style of your home and select complementary door furniture:

French Provincial



Image: Oswald Homes



6357 RN
Page 24



6354 RN
Page 26

Mediterranean



1925 MB
Page 43



9620 MB
Page 24

Modern Farm House



Image: Abbie Melle / @abbie_melle



9707 AB
Page 22



0727 AB
Page 34

Step 2

Select a finish to complement the colour scheme and style of your home:

Polished Brass (PB)

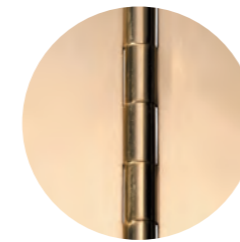

A warm accent

- A classic polished and lacquered finish.
- Finish will age and tarnish over time, developing a unique character.

Durability



Satin Brass (SB)



Soft pops of colour

- Lightly brushed on a polishing wheel for a contemporary look.
- To keep Satin Brass looking stunning year-round, keep dry and clean regularly with a soft cloth.

Durability



Unlacquered Polished Brass (UPB)

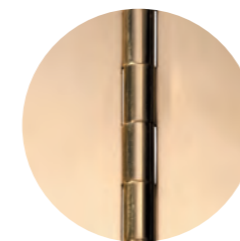

Classic aged charm

- A classic polished and unlacquered finish.
- Designed to age gracefully and naturally, the unlacquered polish will wear through use to develop distinct colour and a timeless aged look.

Durability



Unlacquered Satin Brass (USB)



Contemporary meets classic

- Lightly brushed on a polishing wheel for a contemporary look.
- This modern unlacquered finish will age naturally over time to offer seamless application in both classic and contemporary spaces.

Durability



Antique Brass (AB)



Earthy undertones

- Each product in this finish is hand aged, meaning each product has its own distinct variation and depth of colour, reflecting a mix of lighter and darker finishes.
- This unique finish is designed to wear and age naturally over time, developing beautiful variations in the depth of colour.

Durability



Step 2

Select a finish to complement the colour scheme and style of your home:

Antique Copper (AC)

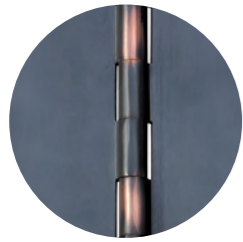

A great heritage look

- Each product in this finish is hand aged, meaning each product has its own distinct variation and depth of colour.
- Designed to age, this finish will continue to wear and form distinct characteristics that look beautiful at every stage of its life.

Durability



Matt Black (MB)



Timeless all rounder

- This highly-durable finish is achieved through powder-coating or an ageing process depending on the product.

Durability



Chrome Plate (CP)

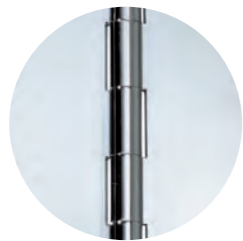

Sleek and adaptable

- Chrome plating not only looks stunning but is incredibly durable.
- This finish will remain at its best for years to come with occasional cleaning to maintain its lustre and brightness.

Durability



Satin Chrome (SC)



Modern and refined

- We achieve this finish by carefully brushing Chrome Plate to remove shine and develop a sleek satin finish.
- Occasional cleaning will keep this highly-durable finish looking its best for years to come.

Durability



Rumbled Nickel (RN)

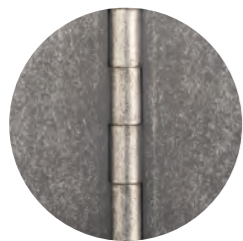

Character filled

- This unique finish is achieved through traditional methods to create something truly special.
- Nickel-plating is aged before each product is 'rumbled' with small stones to reveal glimpses of the nickel through the antique finish.

Durability



Polished Nickel (PN)



Elegant neutral

- A highly durable finish that is warmer than chrome.
- Highly polished nickel-plate gives this finish its beautiful depth of colour.
- Regular cleaning will maintain the lustre of this finish.

Durability



Satin Nickel (SN)



Understated and chic

- Soft to the touch and exhibiting warm hues.
- To achieve this finish, nickel-plated brass is very lightly finished, before being plated with satin nickel.

Durability



Other finishes you may come across

- BR** - Brown
- BL** - Black
- WH** - White
- IV** - Ivory
- PM** - Polished Metal
- AF** - Antique Finish
- PVD** - Anti-tarnish Brass
- EB** - Electro-plated Brass

Step 3

Choose the correct locking mechanism:

Passage Set

Used when a door doesn't need to be locked.

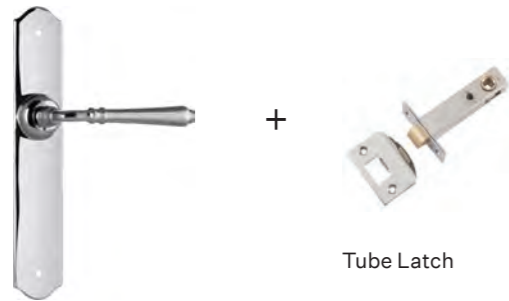

Tube Latch

Lever on Rose Passage Set

Used when a door doesn't need to be locked.

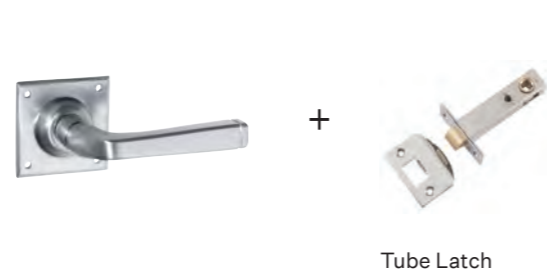

Tube Latch

Privacy Set

Ideal for bathrooms, they have a thumb turn for privacy.



Tube Latch

Privacy Bolt

Privacy Lock

Lever on Rose Privacy Set

Ideal for bathrooms, they have a thumb turn for privacy.



Tube Latch

Privacy Bolt

Privacy Turn

Rebated Locks

Rebated doors are commonly referred to as french doors, they are designed to interlock to avoid swinging open.



Rebated Euro Lock

Euro Cylinder

Flush Bolt (french doors)

Step 4

Choose the most appropriate hinge for your door type – consider height, weight and door thickness.

All TradCo hinges are solid brass and supplied with matching stainless-steel screws, solid brass screws are also available.



Ball Bearing

- A premium hinge
- Durable, smoother and quieter
- Can be used on solid core doors, both external and internal (including some oversized doors)



Fixed Pin (Butt Hinge)

- Standard choice for internal or external doors which are not too heavy
- Mortice flush into jam and door



Hirline

- Easy to install, don't need to be recessed into door
- For internal light-weight doors



Loose Pin

- Loose pin enables easier removal of doors; simply remove the pin rather than unscrewing the hinge
- For internal doors only



Broad Butt

- Great for doors that need a wide throw or to open parallel to the wall
- Often used on double or french doors



Lift Off

- Typically used on toilet and bathroom doors so that in an emergency the door may be removed easily without unscrewing the hinge



Parliament

- A traditional version of the Broad Butt hinge

Step 5

Match accessories to your selected door furniture:

Match your lever or knob to other front door accessories. For example, knockers, bells and centre door knobs.



Image Credit: Sen Built



1258 CP
Page 39



1275 CP
Page 46



1308 CP
Page 37

Don't forget other elements of your door for example, bolts and door stops.



Image Credit: Hilary Walker



1412 AC
Page 81



1513 AC
Page 49



1509 AC
Page 48

Match your lighting and electrical fittings.



Image Credit: Marnie Hawson



5351 MB
Page 124



5310 MB
Page 118



5349 MB
Page 124

Find matching window fittings to suit, such as stays, sash lifts and window fasteners.



Image Credit: Hilary Walker



2315 AB
Page 85



2311 AB
Page 88



2302 AB
Page 95

It's important to also tie in lock elements such as cylinders, faceplate, privacy turns and escutcheons (depending on the lock functionality needed).

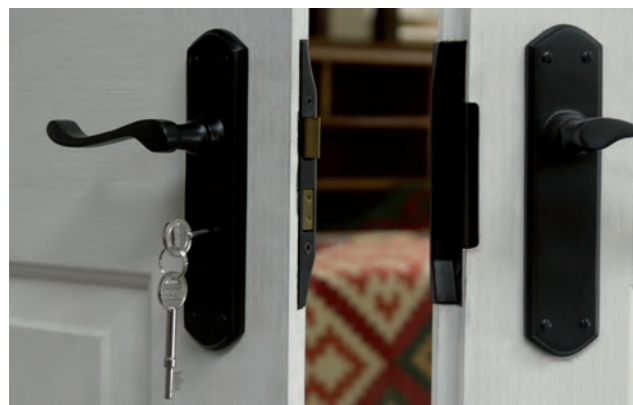

2187 MB
Page 54



2057 MB
Page 58



2055 MB
Page 60

Carry through to your kitchen cabinetware fittings.



Image Credit: Abbie Melle



9693 MB
Page 136



9565 MB
Page 130



9689 MB
Page 130



21350 UPB - Victorian Lever in Unlacquered Polished Brass, gracefully ageing over time • Page 22

Unlacquered Finishes

Unlacquered brass finishes are natural living finishes that patina beautifully with use, creating a raw, unpretentious, rich and layered look. Dulled by age, and naturally polished from regular touch, these finishes are character-filled and perfectly suited to a TradCo restoration home.

With no protective coating on the brass, depending on location and environmental factors, it can take as little as two days or as long as two years for the metal to age, darken and develop to this charming, aged state. The natural beauty of the unlacquered brass ageing process creates an organic quality with distinct darkened colour and variations in texture, that it is continually changing and developing in your home over time.

This low-maintenance finish is ideal for those with a love for beautifully aged hardware.

Unlacquered polished brass and unlacquered satin brass finishes are available on selected products in the TradCo collection.



Door Furniture

Door Levers	20
Iron Levers	27
Door Knobs • Sheet Brass	29
Door Knobs	34
Centre Door Knobs	37
Door Knockers	39
Pull Handles	41
Push Plates	46
Flush Pulls	46
Door Stops	48



Scan to explore our collection of Door Furniture

Door Levers

Milton • Long Backplate (W50xH200xP68mm)



1004 PB Latch
1004E PB Euro
1004P PB Privacy
1005 PB Lock



0786 AB Latch
0786E AB Euro
0786P AB Privacy
0787 AB Lock



1014 AC Latch
1014E AC Euro
1014P AC Privacy
1015 AC Lock



9610 MB Latch
9610E MB Euro
9610P MB Privacy
9611 MB Lock



0790 CP Latch
0790E CP Euro
0790P CP Privacy
0791 CP Lock



0794 SC Latch
0794E SC Euro
0794P SC Privacy
0795 SC Lock

Milton • Round Rose (P68mm, BP63mm)



1007 PB



0789 AB



1017 AC



9613 MB



0793 CP



0797 SC

Windsor (W45xH200xP60mm)



1042 PB Latch
1042E PB Euro
1042P PB Privacy
1043 PB Lock



21351 UPB Latch
21351E UPB Euro
21351P UPB Privacy
21352 UPB Lock



0858 AB Latch
0858E AB Euro
0858P AB Privacy
0859 AB Lock



1047 AC Latch
1047E AC Euro
1047P AC Privacy
1048 AC Lock



0890 CP Latch
0890E CP Lock
0890P CP Privacy
0891 CP Lock



0892 SC Latch
0892E SC Euro
0892P SC Privacy
0893 SC Lock



1927 MB Latch
1927E MB Euro
1927P MB Privacy
1928 MB Lock

Door Levers

Camden (W50xH152xP60mm)



1076 PB Latch
1076E PB Euro
1076P PB Privacy
1077 PB Lock



6635 SB Latch
6635E SB Euro
6635P SB Privacy
6636 SB Lock



9709 AB Latch
9709E AB Euro
9709P AB Privacy
9710 AB Lock



9618 MB Latch
9618E MB Euro
9618P MB Privacy
9619 MB Lock



0876 CP Latch
0876E CP Euro
0876P CP Privacy
0877 CP Lock



21594 SC Latch
21594E SC Euro
21594P SC Privacy
21595 SC Lock



6555 SN Latch
6555E SN Euro
6555P SN Privacy
6556 SN Lock

Victorian • Long Backplate (W42xH152xP59mm)



1037 PB Latch
1037E PB Euro
1037P PB Privacy
1038 PB Lock



0782 AB Latch
0782E AB Euro
0782P AB Privacy
0783 AB Lock



0902 AC Latch
0902E AC Euro
0902P AC Privacy
0903 AC Lock



1930 MB Latch
1930E MB Euro
1930P MB Privacy
1931 MB Lock



0907 CP Latch
0907E CP Euro
0907P CP Privacy
0908 CP Lock



0912 SC Latch
0912E SC Euro
0912P SC Privacy
0913 SC Lock

Door Levers

Victorian • Round Rose (P58mm, BP63mm)



1039 PB
21350 UPB



0850 AB



0900 AC



1929 MB



1044 CP



0901 SC

Fremantle (W35xH150xP50mm)



1025 PB Latch
1025E PB Euro
1025P PB Privacy
1026 PB Lock



0845 AB Latch
0845E AB Euro
0845P AB Privacy
0846 AB Lock



0895 AC Latch
0895E AC Euro
0895P AC Privacy
0896 AC Lock



9616 MB Latch
9616E MB Euro
9616P MB Privacy
9617 MB Lock



1045 CP Latch
1045E CP Euro
1045P CP Privacy
1046 CP Lock



0897 SC Latch
0897E SC Euro
0897P SC Privacy
0898 SC Lock

Henley (W50xH180xP58mm)



1074 PB Latch
1074E PB Euro
1074P PB Privacy
1075 PB Lock



6633 SB Latch
6633E SB Euro
6633P SB Privacy
6634 SB Lock



9707 AB Latch
9707E AB Euro
9707P AB Privacy
9708 AB Lock



9614 MB Latch
9614E MB Euro
9614P MB Privacy
9615 MB Lock



0874 CP Latch
0874E CP Euro
0874P CP Privacy
0875 CP Lock



21596 SC Latch
21596E SC Euro
21596P SC Privacy
21597 SC Lock



Door Levers

Reims • Long Backplate (W43xH240xP70mm)



0771 PB Latch
0771E PB Euro
0771P PB Privacy
0772 PB Lock



6640 SB Latch
6640E SB Euro
6640P SB Privacy
6641 SB Lock



0774 AB Latch
0774E AB Euro
0774P AB Privacy
0775 AB Lock



0746 AC Latch
0746E AC Euro
0746P AC Privacy
0747 AC Lock



9620 MB Latch
9620E MB Euro
9620P MB Privacy
9621 MB Lock



0777 CP Latch
0777E CP Euro
0777P CP Privacy
0778 CP Lock



0749 SC Latch
0749E SC Euro
0749P SC Privacy
0750 SC Lock



6357 RN Latch
6357E RN Euro
6357P RN Privacy
6358 RN Lock



6560 SN Latch
6560E SN Euro
6560P SN Privacy
6561 SN Lock

Codes for Unlacquered Brass Finishes:

21353 UPB Latch
21353E UPB Euro
21353P UPB Privacy
21354 UPB Lock

21355 USB Latch
21355E USB Euro
21355P USB Privacy
21356 USB Lock

Reims • Short Backplate (W43xH110xP65mm)



0773 PB
21360 UPB

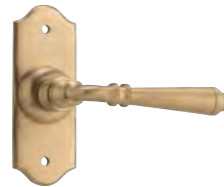

6642 SB
21357 USB



0776 AB



0748 AC



9622 MB



0779 CP



0751 SC



6359 RN



6562 SN



Door Levers

Menton • Long Backplate (W50xH225xP75mm)



0675 PB Latch
0675E PB Euro
0675P PB Privacy
0676 PB Lock



6637 SB Latch
6637E SB Euro
6637P SB Privacy
6638 SB Lock



21358 USB Latch
21358E USB Euro
21358P USB Privacy
21359 USB Lock



0678 AB Latch
0678E AB Euro
0678P AB Privacy
0679 AB Lock



0681 AC Latch
0681E AC Euro
0681P AC Privacy
0682 AC Lock



9626 MB Latch
9626E MB Euro
9626P MB Privacy
9627 MB Lock



0684 CP Latch
0684E CP Euro
0684P CP Privacy
0685 CP Lock



0687 SC Latch
0687E SC Euro
0687P SC Privacy
0688 SC Lock



6354 RN Latch
6354E RN Euro
6354P RN Privacy
6355 RN Lock



6557 SN Latch
6557E SN Euro
6557P SN Privacy
6558 SN Lock

Menton • Square Rose (W60xH60xP70mm)



0677 PB



6639 SB
21361 USB



0680 AB



0683 AC



9628 MB



0686 CP



0689 SC



6356 RN



6559 SN

Door Levers

Retro (W40xH150xP57mm)



0820 CP Latch
0820E CP Euro
0820P CP Privacy
0821 CP Lock

Mid Century (W35xH145xP47mm)



0822 CP Latch
0822E CP Euro
0822P CP Privacy
0823 CP Lock

Balmoral (W42xH156xP46mm)



0867 CP Latch
0867E CP Euro
0867P CP Privacy
0868 CP Lock



0977 SC Latch
0977E SC Euro
0977P SC Privacy
0978 SC Lock

Exeter • Round Rose (P66mm, BP50mm)



0827 PB/IV



0837 AB/IV



0757 CP/WH

Iron Levers

Stratford (W50xH192xP55mm)



1802 MB Latch
1802E MB Euro
1802P MB Privacy
1801 MB Lock

Gloucester (W50xH158xP53mm)



1804 MB Latch
1804E MB Euro
1804P MB Privacy
1803 MB Lock



Door Knobs • Sheet Brass

Nouveau (W58xH188xP60mm)



- 1053 PB Latch**
1053E PB Euro
1053P PB Privacy
1054 PB Lock
- 1063 AC Latch
1063E AC Euro
1063P AC Privacy
1064 AC Lock

Fitzroy (W63xH205xP60mm)



- 0986 PB Latch**
0986E PB Euro
0986P PB Privacy
0987 PB Lock
- 0996 AC Latch
0996E AC Euro
0996P AC Privacy
0997 AC Lock

Bungalow (W68xH197xP60mm)



- 1050 PB Latch**
1050E PB Euro
1050P PB Privacy
1051 PB Lock
- 0830 AB Latch
0830E AB Euro
0830P AB Privacy
0831 AB Lock
- 1060 AC Latch
1060E AC Euro
1060P AC Privacy
1061 AC Lock
- 9630 MB Latch**
9630E MB Euro
9630P MB Privacy
9631 MB Lock
- 0886 CP Latch
0886E CP Euro
0886P CP Privacy
0887 CP Lock
- 0870 SC Latch
0870E SC Euro
0870P SC Privacy
0871 SC Lock

Door Knobs • Sheet Brass

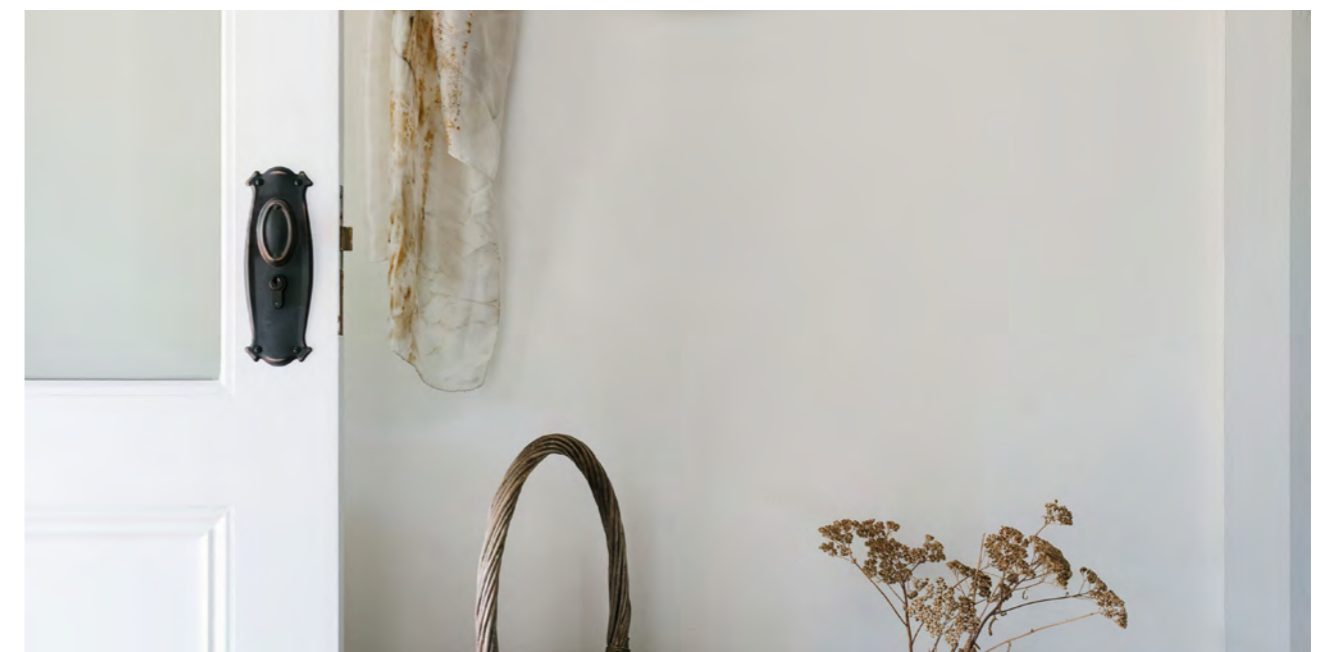

1060 AC • Bungalow Knob • Page 29
Design & Home: Laura Shields
Image Credit: Marnie Hawson / @marniehawson

Door Knobs • Sheet Brass

Kensington
(W58xH175xP57mm)



- 1072 PB Latch**
1072E PB Euro
1072P PB Privacy
1073 PB Lock
- 0856 AB Latch
0856E AB Euro
0856P AB Privacy
0857 AB Lock
- 1082 AC Latch
1082E AC Euro
1082P AC Privacy
1083 AC Lock
- 9632 MB Latch
9632E MB Euro
9632P MB Privacy
9633 MB Lock
- 1092 CP Latch**
1092E CP Euro
1092P CP Privacy
1093 CP Lock
- 0872 SC Latch
0872E SC Euro
0872P SC Privacy
0873 SC Lock

Door Knobs • Sheet Brass

Richmond • Long Backplate
(W50xH200xP62mm)



- 0981 PB Latch**
0981E PB Euro
0981P PB Privacy
0982 PB Lock
- 0841 AB Latch
0841E AB Euro
0841P AB Privacy
0842 AB Lock
- 0991 AC Latch
0991E AC Euro
0991P AC Privacy
0992 AC Lock
- 0881 CP Latch
0881E CP Euro
0881P CP Privacy
0882 CP Lock
- 0884 SC Latch**
0884E SC Euro
0884P SC Privacy
0885 SC Lock

Napier
(W54xH178xP50mm)



- 0800 PB Latch
0800E PB Euro
0800P PB Privacy
0801 PB Lock
- 0802 AC Latch**
0802E AC Euro
0802P AC Privacy
0803 AC Lock
- 0804 CP Latch
0804E CP Euro
0804P CP Privacy
0805 CP Lock

Elwood
(W63xH200xP47mm)



- 1070 PB Latch**
1070E PB Euro
1070P PB Privacy
1071 PB Lock
- 1080 AC Latch
1080E AC Euro
1080P AC Privacy
1081 AC Lock
- 1090 CP Latch
1090E CP Euro
1090P CP Privacy
1091 CP Lock

Richmond • Short Backplate
(W50xH125xP62mm)



- 0980 PB
- 0840 AB
- 0990 AC
- 0880 CP
- 0883 SC

Edwardian
(W60xH185xP57mm)



- 1056 PB Latch**
1056E PB Euro
1056P PB Privacy
1057 PB Lock
- 0854 AB Latch
0854E AB Euro
0854P AB Privacy
0855 AB Lock
- 1066 AC Latch
1066E AC Euro
1066P AC Privacy
1067 AC Lock
- 9634 MB Latch
9634E MB Euro
9634P MB Privacy
9635 MB Lock
- 9746 CP Latch**
9746E CP Euro
9746P CP Privacy
9747 CP Lock
- 9760 SC Latch
9760E SC Euro
9760P SC Privacy
9761 SC Lock

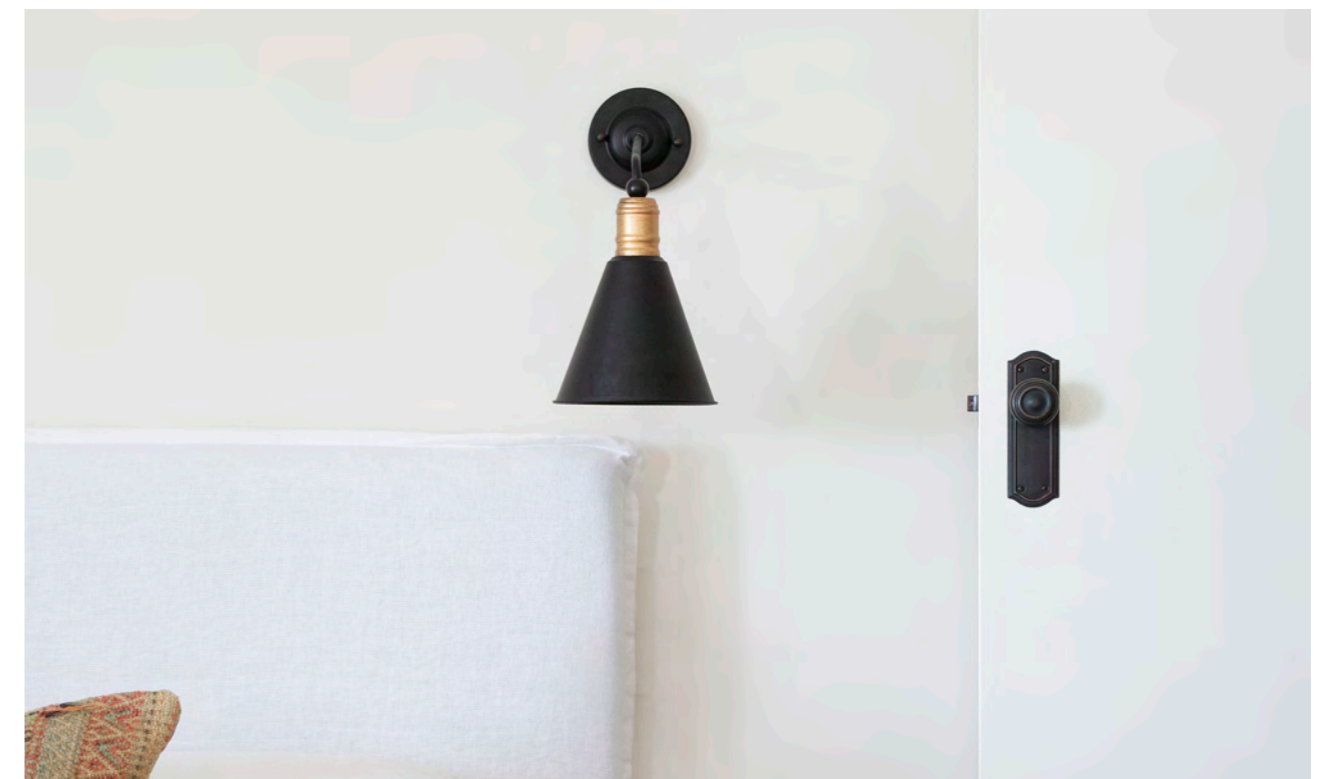

1082 AC • Kensington Door Knob • Page 30
Interior Designer: @jessi.eve
Image Credit: Louise Roche / @villastyling

Door Knobs • Sheet Brass

Milled Edged • Large
(P48xD52mm, BP52mm)



1022 PB
21371 UPB



0852 AB



1010 AC



0929 MB



1009 CP



0889 SC

Milled Edged • Small
(P46xD45mm, BP45mm)



1021 PB
21370 UPB



0851 AB



1032 AC



0928 MB



1031 CP



0888 SC

Door Knobs • Sheet Brass

Plain Mortice
(P53xD54mm, BP54mm)



1024 PB



0853 AB



1011 AC



0930 MB



0998 CP



0999 SC

Retro Fit
(P59xD54mm, BP60mm)



0694 PB



0695 AB



0696 AC



0699 MB



0697 CP



0698 SC

The Retro Fit range (0694 PB - 0698 SC) has been designed to cover pre-existing 54mm holes. Knobs are sheet brass (with threaded spindle) and backplates are forged brass. Matching tie bolts are supplied.

Door Knobs • Sheet Brass

Milled Edge Knob Backplates
(Sold as a pair)



BP 52mm

BP 46mm

1029 PB
0844 AB
0864 AC
0932 MB
0865 CP
0866 SC

1027 PB
0843 AB
0861 AC
0931 MB
0862 CP
0863 SC



1099 Taylor spindles are available for dummy sets.



Door Knobs

Milton • Long Backplate (W50xH200xP73)



0720 PB Latch
0720E PB Euro
0720P PB Privacy
0721 PB Lock

6646 SB Latch
6646E SB Euro
6646P SB Privacy
6647 SB Lock

21362 UPB Latch
21362E UPB Euro
21362P UPB Privacy
21363 UPB Lock

21366 USB Latch
21366E USB Euro
21366P USB Privacy
21367 USB Lock

0724 AB Latch
0724E AB Euro
0724P AB Privacy
0725 AB Lock



0728 AC Latch
0728E AC Euro
0728P AC Privacy
0729 AC Lock

6450 MB Latch
6450E MB Euro
6450P MB Privacy
6451 MB Lock

0732 CP Latch
0732E CP Euro
0732P CP Privacy
0733 CP Lock

0736 SC Latch
0736E SC Euro
0736P SC Privacy
0737 SC Lock

6566 SN Latch
6566E SN Euro
6566P SN Privacy
6567 SN Lock

Milton • Round Rose (P65xD54mm, BP57mm)



0723 PB 6649 SB 21365 UPB 21369 USB 0727 AB



0731 AC 6453 MB 0735 CP 0739 SC 6569 SN

Door Knobs

Victorian • Round Rose (D54xP68mm, BP57mm)



1020 PB 0784 AB



1030 AC 0961 MB



1040 CP 1041 SC

Victorian • Long Backplate (W42xH152xP75mm)



1035 PB Latch
1035E PB Euro
1035P PB Privacy
1036 PB Lock

0780 AB Latch
0780E AB Euro
0780P AB Privacy
0781 AB Lock

0905 AC Latch
0905E AC Euro
0905P AC Privacy
0906 AC Lock



0959 MB Latch
0959E MB Euro
0959P MB Privacy
0960 MB Lock

0910 CP Latch
0910E CP Euro
0910P CP Privacy
0911 CP Lock

0915 SC Latch
0915E SC Euro
0915P SC Privacy
0916 SC Lock

Reeded (P81xD51mm, BP60mm)



1028 PB 0860 AB



1034 AC 9629 MB

Porcelain • Zinc Alloy Backplate (D55xP57mm, BP55mm)



1000 MB/WH



1001 PB/WH



Door Knobs

Fluted • Iron
(D55xP80mm BP60mm)



1012 AF 1013 PM

Filigree
(P78xD63mm, BP66mm)



0933 PB 20370 MB

Centre Door Knobs

Classic
(P86mm, BP85mm)



1306 PB 21378 UPB 2366 AB 1305 AC 9679 MB 1308 CP 1309 SC

Ornate
(P73mm, BP80mm)



1303 PB 2365 AB 1304 AC 20371 MB

Filigree
(P65mm, BP66mm)



1307 PB 20372 MB



A. 1258 CP • Victorian Door Knocker • Page 39
 B. 0888E CP • Richmond Door Knob • Page 31
 Starmore Property by Select Construction and Justin Long Architects
 Image Credit: Simon Whitbread Photography



Door Knockers

Lion
 (Face fix, D93mm, BP103x135mm, P55mm, Ring D100mm, P22mm)



9330 PB



9331 AB



9333 MB

Victorian
 (W45xH185mm)



1256 PB
 21377 UPB



2361 AB



1257 AC



9678 MB



1258 CP



1259 SC

Federation
 (W80xH210mm)



1252 PB



2360 AB



1253 AC



20373 MB

Edwardian
 (W75xH175mm)



1255 PB



20374 MB



1285 PM (Iron)



A. 2034 AC • Classic Offset Pull Handle • Page 41
 B. 2041 AC • Euro Sheet Brass Escutcheon & Matching Cylinder • Page 58
 Image Credit: Hilary Walker / @hilarywalkerphotography
 Featured in @houseofmudandstraw



Pull Handles

Victorian Cylinder Hole (W70xH255xP57mm)

*Suits most popular brand cylinder dead latches.
 Hole measurement 33mm outer/29mm inner.



Cylinder Hole (W50xH185xP28mm)

*Suits most popular brand cylinder dead latches.
 Hole measurement 33mm outer/29mm inner.



Classic Offset (W42xH305xP60mm)



Pull Handles

Offset Backplate (W50xH250xP50mm)



1468 PB

2362 AB

1478 AC

9673 MB

2930 CP

2931 SC

Deco (W60xH240xP60mm)



2900 PB

2901 AC

2902 CP

Deco Pull Handle/Knocker (W60xH240xP60mm)

*Suits most popular brand cylinder dead latches.
Hole measurement 33mm outer/29mm inner.



1297 PB

1298 AC

1299 CP

Bar Pull (H420xP92mm)



2926 PB

2284 AB

2927 AC

Nouveau Offset (W75xH225xP35mm)



1483 PB

1488 AC

Pull Handles

Ornate (W38xH170xP32mm)



1497 PB

20375 MB

Iron Wire Twist



3087 MB
(H200xP70mm)

1863 MB
(H125xP50mm)

Iron Twist



3060 MB
(H187xP39mm)

3062 MB
(H145xP39mm)

Iron Door Pulls

Iron pull handles are handmade.
Minor variations in size and shape are to be expected.



1922 MB Bar
(H420xP92mm)

1924 MB Square
(H450xP62mm)

1925 MB Strap
(H510xP55mm)



1867 MB Offset
(H265xP60mm)

Fleur-de-Lis



1458 PB
(H230xP35mm)

1457 PB
(H165xP26mm)

1456 PB
(H130xP23mm)



1865 MB • Iron
(H180xP32mm)



1866 MB • Iron
(H175xP29mm)



1455 PB
(H100xP23mm)

Pull Handles

Offset Banded (H180xP41mm)



1460 PB 6688 SB 2346 AB 1480 AC 1811 MB 1490 CP 1491 SC

Offset



1486 PB (H130xP23mm) 1485 PB (H100xP20mm) 2345 AB (H130xP23mm) 2344 AB (H100xP20mm) 1449 AC (H130xP23mm) 1448 AC (H100xP20mm) 9655 MB (H130xP23mm) 9654 MB (H100xP20mm)



1482 CP (H130xP23mm) 1481 CP (H100xP20mm) 1375 SC (H130xP23mm) 1374 SC (H100xP20mm)

Standard



1463 PB (H150xP28mm) 1462 PB (H125xP26mm) 1461 PB (H100xP26mm) 9722 AB (H150xP28mm) 9721 AB (H125xP26mm) 9720 AB (H100xP26mm) 9745 AC (H150xP28mm) 9744 AC (H125xP26mm) 9743 AC (H100xP26mm)

Pull Handles

Standard



9669 MB (H150xP28mm) 9668 MB (H125xP26mm) 9667 MB (H100xP26mm) 1476 CP (H150xP28mm) 1475 CP (H125xP26mm) 1474 CP (H100xP26mm) 1373 SC (H150xP28mm) 1372 SC (H125xP26mm) 1371 SC (H100xP26mm)

Telephone



1453 PB (H187xP45mm) 1452 PB (H150xP43mm) 1451 PB (H125xP35mm) 1450 PB (H110xP30mm) 2343 AB (H187xP45mm) 2342 AB (H150xP43mm) 2341 AB (H125xP35mm) 2340 AB (H110xP30mm)



1473 AC (H187xP45mm) 1472 AC (H150xP43mm) 1471 AC (H125xP35mm) 1470 AC (H110xP30mm) 1967 MB (H187xP45mm) 1966 MB (H150xP43mm) 1965 MB (H125xP35mm) 1964 MB (H110xP30mm)



2948 SC (H187xP45mm) 2947 SC (H150xP43mm) 2946 SC (H125xP35mm) 2945 SC (H110xP30mm)

Push Plates

Milton (W75xH300mm)



1008 PB 2357 AB 1018 AC 9680 MB 1275 CP 1276 SC

Flush Pulls

Traditional (W43xH150xDE10mm)



1575 PB 6690 SB 2349 AB 1576 AC 1805 MB 1574 CP



1577 SC 6430 RN 6530 PN 6610 SN

Flush Pulls

Classic • Large (W32xH140xDE8mm)



1569 PB 4842 SB 2348 AB 1579 AC 1585 MB 1589 CP 1587 SC

Classic • Small (W28xH88xDE4mm)



1568 PB 4843 SB 2347 AB 1578 AC 1584 MB 1588 CP 1586 SC

Classic (W90xH55mmDE6mm)



1571 PB 1563 AC 1564 CP

Ring (W50xH63mmDE13mm)



1573 PB 1581 AC

Cellar Door Pulls (W63xH63mmDE6mm)



1580 PB 9817 AC

Door Stops

Magnetic (P75xD44mm)



Concealed Fix (2 sizes available)



Traditional (P75mm BP35x35mm)



Hook (P70xD39mm)



Door Stops

Oval Door Stops (H29xD40mm)



Domed Door Stops (H50xD30mm)



Oval Door Stop Spacers H15xD40mm



9843 PB
9844 AB
9845 AC
9846 MB
9847 CP
9848 SC
9851 PN
9852 SN
4508 SB



A. 2010 MB • Ornate Rim Lock • Page 61
B. 1021 PB • Milled Edge Door Knob • Page 32
Featured in @lumiere lodge
Image Credit: Marnie Hawson / @marniehawson

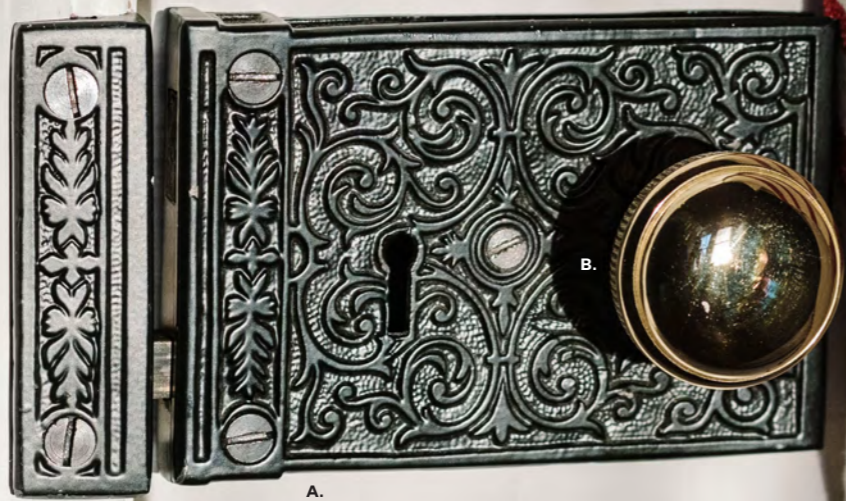

A.

B.

Locks, Latches & Hinges

Internal Locks	52
External Locks	53
Tube Latches & Privacy Turns	56
Escutcheons	58
Euro Cylinders	60
Rim Locks & Accessories	61
Screen Door Latches	62
French Door Fasteners	63
Hinges	64



Scan to explore our collection of Locks, Latches & Hinges

Internal Locks

3 Lever (Low Security)

- Solid brass face & striker plates
- Reversible tongue
- Keypad alike or random keyed
- 57 & 44mm backsets

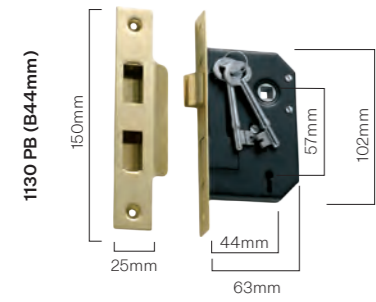
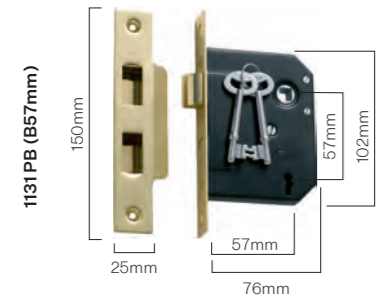

1131 PB
B57mm

1130 PB
B44mm



2201 AB
B57mm

2200 AB
B44mm



1141 AC
B57mm

1140 AC
B44mm



2261 MB
B57mm

2260 MB
B44mm



2211 CP
B57mm

2210 CP
B44mm



1133 SC
B57mm

1132 SC
B44mm

Rebated 3 Lever (Low Security)

- Solid brass face & striker plates
- Reversible tongue
- Keypad alike or random keyed
- 13mm rebate
- 57 & 44mm backsets

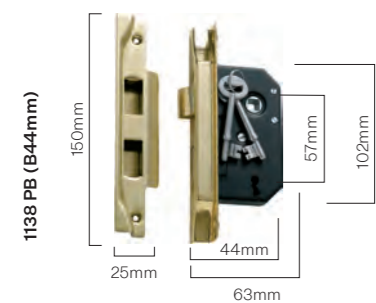
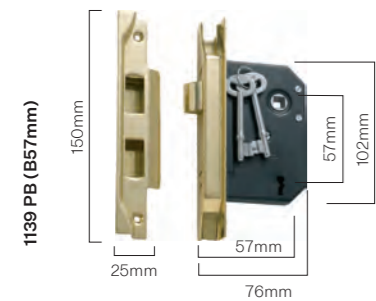

1139 PB
B57mm

1138 PB
B44mm



2205 AB
B57mm

2204 AB
B44mm



1149 AC
B57mm

1148 AC
B44mm



2265 MB
B57mm

2264 MB
B44mm



2215 CP
B57mm

2214 CP
B44mm



1159 SC
B57mm

1158 SC
B44mm

*Spare keys (1129) are available for 3 lever locks.
Please quote key number when ordering.

Internal Locks

Privacy (Low Security)

- Solid brass face & striker plates
- Reversible tongue
- 57 & 44mm backsets

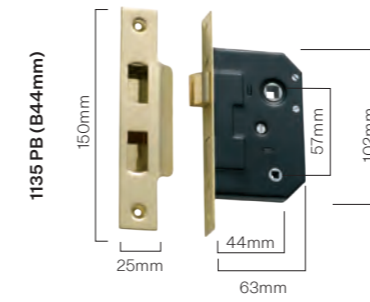
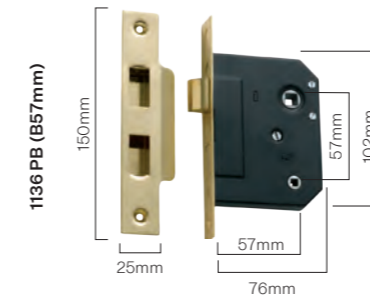

1136 PB
B57mm

1135 PB
B44mm



2203 AB
B57mm

2202 AB
B44mm



1146 AC
B57mm

1145 AC
B44mm



2263 MB
B57mm

2262 MB
B44mm



2213 CP
B57mm

2212 CP
B44mm



1143 SC
B57mm

1142 SC
B44mm

External Locks

5 Lever (High Security)

- Solid brass face & striker plates
- Reinforced steel pins
- Anti pick curtain
- Reversible tongue
- 57 & 46mm backsets
- Keypad alike or random keyed
- Tested over 130,000 cycles
- Fitting instructions supplied
- Download template from website

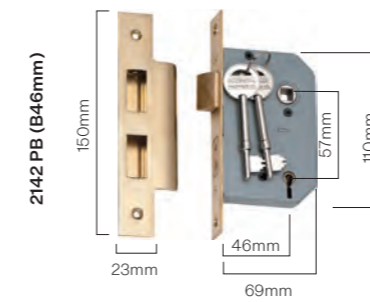
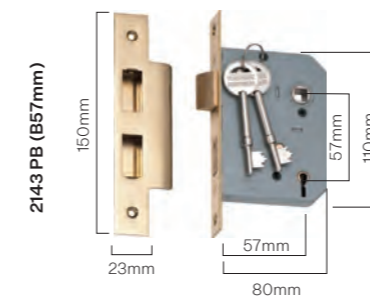

2143 PB
B57mm

2142 PB
B46mm



4046 SB
B57mm

4045 SB
B46mm



2151 AB
B57mm

2150 AB
B46mm



2159 AC
B57mm

2158 AC
B46mm



2183 MB
B57mm

2182 MB
B46mm



2167 CP
B57mm

2166 CP
B46mm



2175 SC
B57mm

2174 SC
B46mm



6153 RN
B57mm

6152 RN
B46mm



6161 PN
B57mm

6160 PN
B46mm



6169 SN
B57mm

6168 SN
B46mm

External Locks

Rebated 5 Lever (High Security)

- Solid brass face & striker plates
- Reinforced steel pins
- Anti pick curtain
- Reversible tongue
- Keyed alike or random keyed
- Tested over 130,000 cycles
- Fitting instructions supplied
- Download template from website
- 13mm rebate
- 57 & 46mm backsets

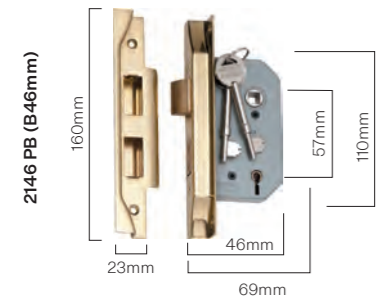
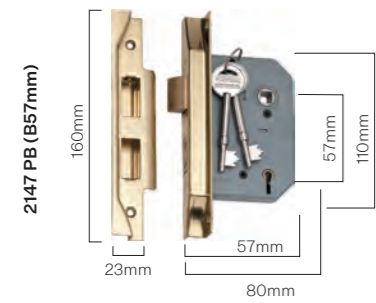

2147 PB
B57mm
2146 PB
B46mm



4050 SB
B57mm
4051 SB
B46mm



2155 AB
B57mm
2154 AB
B46mm



2163 AC
B57mm
2162 AC
B46mm



2187 MB
B57mm
2186 MB
B46mm



2171 CP
B57mm
2170 CP
B46mm



2179 SC
B57mm
2178 SC
B46mm



6157 RN
B57mm
6156 RN
B46mm



6165 PN
B57mm
6164 PN
B46mm



6173 SN
B57mm
6172 SN
B46mm

*Spare keys (2140) are available for 5 lever locks. Please quote key number when ordering.

Euro (High Security)

- Solid brass face & striker plates
- Reinforced steel pins
- Latch retraction
- Reversible tongue
- 57 & 46mm backsets
- Tested over 130,000 cycles
- Fitting instructions supplied
- Download template from website

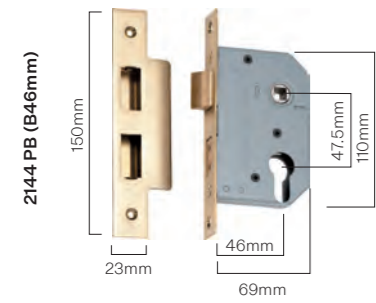
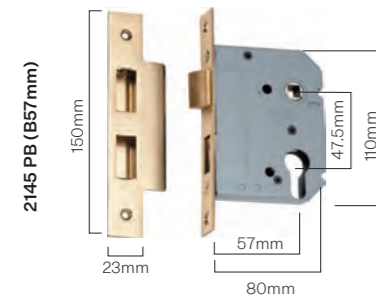

2145 PB
B57mm
2144 PB
B46mm



4048 SB
B57mm
4047 SB
B46mm



2153 AB
B57mm
2152 AB
B46mm



2161 AC
B57mm
2160 AC
B46mm



2185 MB
B57mm
2184 MB
B46mm



2169 CP
B57mm
2168 CP
B46mm



2177 SC
B57mm
2176 SC
B46mm



6155 RN
B57mm
6154 RN
B46mm



6163 PN
B57mm
6162 PN
B46mm



6171 SN
B57mm
6170 SN
B46mm



A. 0748 AC • Reims Door Lever • Page 24 / B. 1167 AC • Round Privacy Turn • Page 58
Featured in: Capella Constructions
Image Credit: Jody D'Arcy / @jody_darcy

Rebated Euro (High Security)

- Solid brass face & striker plates
- Reinforced steel pins
- Latch retraction
- Reversible tongue
- 57 & 44mm backsets
- Tested over 130,000 cycles
- Fitting instructions supplied
- Download template from website
- 13mm rebate

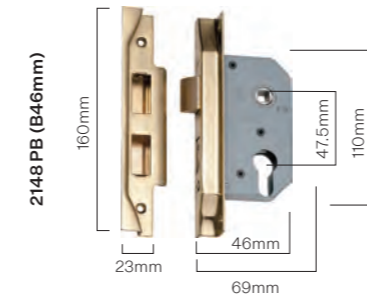
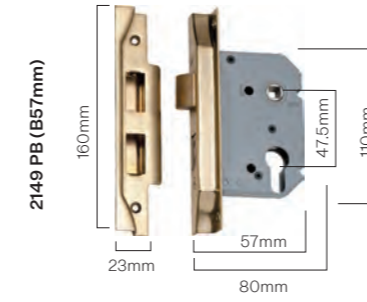

2149 PB
B57mm
2148 PB
B46mm



4052 SB
B57mm
4053 SB
B46mm



2157 AB
B57mm
2156 AB
B46mm



2165 AC
B57mm
2164 AC
B46mm



2189 MB
B57mm
2188 MB
B46mm



2173 CP
B57mm
2172 CP
B46mm



2181 SC
B57mm
2180 SC
B46mm



6159 RN
B57mm
6158 RN
B46mm



6167 PN
B57mm
6166 PN
B46mm



6175 SN
B57mm
6174 SN
B46mm

Tube Latches & Privacy Turns

Split Cam Tube Latches (Brass face plate and striker, 3 different backset sizes)

Measurements also apply to privacy bolts.

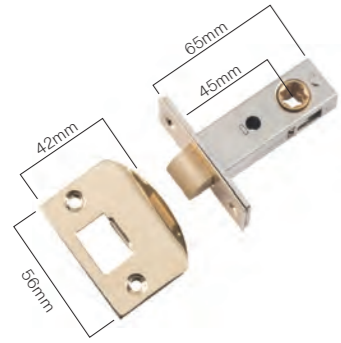

9570 PB
B45mm

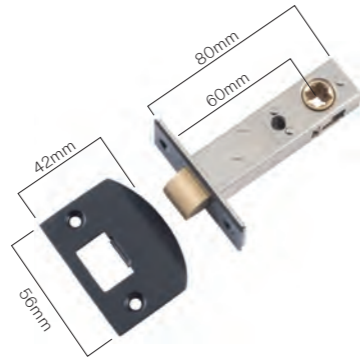

9586 MB
B60mm

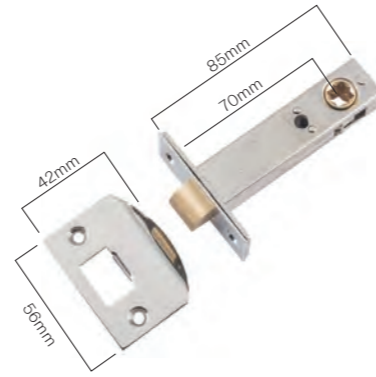

6220 PN
B70mm

Finish	Backset Size	Split Cam Tube Latch	Hard Sprung Split Cam Tube Latch	Finish	Backset Size	Split Cam Tube Latch	Hard Sprung Split Cam Tube Latch
Polished Brass	45mm	9570 PB	21510 PB	Chrome Plate	45mm	9579 CP	21522 CP
	60mm	9571 PB	21511 PB		60mm	9580 CP	21523 CP
	70mm	9572 PB	21512 PB		70mm	9581 CP	21524 CP
Satin Brass	45mm	6224 SB	21528 SB	Satin Chrome	45mm	9582 SC	21525 SC
	60mm	6225 SB	21529 SB		60mm	9583 SC	21526 SC
	70mm	6226 SB	21530 SB		70mm	9584 SC	21527 SC
Antique Brass	45mm	9573 AB	21513 AB	Rumbled Nickel	45mm	6215 RN	21531 RN
	60mm	9574 AB	21514 AB		60mm	6216 RN	21532 RN
	70mm	9575 AB	21515 AB		70mm	6217 RN	21533 RN
Antique Copper	45mm	9576 AC	21516 AC	Polished Nickel	45mm	6218 PN	21534 PN
	60mm	9577 AC	21517 AC		60mm	6219 PN	21535 PN
	70mm	9578 AC	21518 AC		70mm	6220 PN	21536 PN
Matt Black	45mm	9585 MB	21519 MB	Satin Nickel	45mm	6221 SN	21537 SN
	60mm	9586 MB	21520 MB		60mm	6222 SN	21538 SN
	70mm	9587 MB	21521 MB		70mm	6223 SN	21539 SN

Tube Latches & Privacy Turns

Tube Latch Striker • Extra Long



2091 PB
2092 AB
2093 AC
2098 MB
2094 CP
2097 SC

(W53xH56mm)

Rebate Extension Plates



2235 PB
2236 AB
2237 AC
2243 MB
2238 CP
2239 SC

(W45xH88mm)

Rebate Kits



9552 PB
6246 SB
9553 AB
9554 AC
9557 MB

9555 CP
9556 SC
6243 RN
6244 PN
6245 SN

(DE13mm)
– suits split cam tube latches

Privacy Bolts (Brass face plate and striker, 3 different backset sizes)



9590 PB
B70mm
9589 PB
B60mm
9588 PB
B45mm



6241 SB
B70mm
6240 SB
B60mm
6239 SB
B45mm



9593 AB
B70mm
9592 AB
B60mm
9591 AB
B45mm



9596 AC
B70mm
9595 AC
B60mm
9594 AC
B45mm



9605 MB
B70mm
9604 MB
B60mm
9603 MB
B45mm



9599 CP
B70mm
9598 CP
B60mm
9597CP
B45mm



9602 SC
B70mm
9601 SC
B60mm
9600 SC
B45mm



6232 RN
B70mm
6231 RN
B60mm
6230 RN
B45mm



6235 PN
B70mm
6234 PN
B60mm
6233 PN
B45mm



6238 SN
B70mm
6237 SN
B60mm
6236 SN
B45mm

Tube Latches & Privacy Turns

Round Privacy Turns D35mm (spindle supplied)



Privacy Adaptors

Spindle supplied (H4.65xW4.65xL70mm),
supplied with all privacy door furniture.



1156 PB 1162 SC
2207 AB 6347 RN
7733 SB 6470 PN
1166 AC 6550 SN
1889 MB 21398 UPB
1168 CP 21399 USB

Escutcheons

Pressed • Sheet Brass (W30xH44mm)



A. 1001 PB/WH • Porcelain Door Knob • Page 35 / B. 1184 PB • Pressed Escutcheon • Page 59



Escutcheons

Euro • Sheet Brass (Concealed fix, D50xP10mm, Sold Individually)



Covered (W20xH60mm)



Euro Cylinders

Dual Function



Key/Thumb Turn



*Dual Function

Key can be left in the cylinder on the inside of the door and still allow a key to be inserted and function the lock from outside.

Euro Cylinder Information (Solid Brass, C4, 5 Pin)

Code	Function	Finish	Code	Function	Finish
Length 65mm			Length 80mm		
21600	Dual Function	Polished Brass	21730	Dual Function	Satin Brass
21606	Dual Function	Satin Brass	21651	Dual Function	Antique Brass
21601	Dual Function	Antique Brass	21653	Dual Function	Matt Black
21602	Dual Function	Antique Copper	21656	Dual Function	Satin Chrome
21603	Dual Function	Matt Black			
21604	Dual Function	Chrome Plate			
21605	Dual Function	Satin Chrome			
21607	Dual Function	Rumbled Nickel			
21608	Dual Function	Polished Nickel			
21609	Dual Function	Satin Nickel			
21610	Key/Thumb	Polished Brass			
21616	Key/Thumb	Satin Brass			
21611	Key/Thumb	Antique Brass			
21612	Key/Thumb	Antique Copper			
21613	Key/Thumb	Matt Black			
21614	Key/Thumb	Chrome Plate			
21615	Key/Thumb	Satin Chrome			
21617	Key/Thumb	Rumbled Nickel			
21618	Key/Thumb	Polished Nickel			
21619	Key/Thumb	Satin Nickel			

Rim Locks & Accessories

Rim Locks (Low Security)

*Door furniture to suit on Page 32

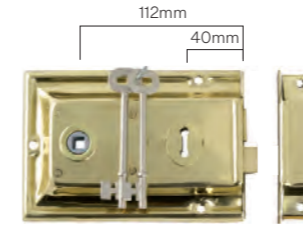

2002 PB (W155xH105mm)



2000 MB/PB (W155xH105mm)



2013 MB (W155xH105mm)

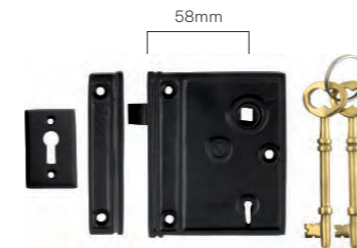

2011 MB Rim Lock (W80xH95mm)

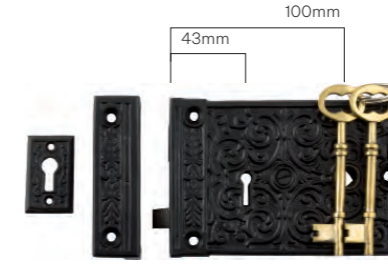

2010 MB Ornat Rim Lock (W130xH90mm)



2001 Spare Key - Suits 2000/2002/2013



2007 Spare Key - Suits 2005/2006
2012 Spare Key - Suits 2011
2019 Spare Key - Suits 2017/2018
2009 Spare Key - Suits 2010



2005 LH AF • Carpenters Lock • Page 62



Rim Locks & Accessories

Carpenters Locks • Cast Iron

*Tongues not reversible.

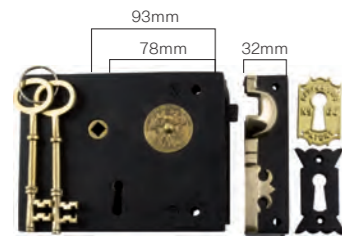

2017 LH AF
(W150xH120mm)



2018 RH AF
(W150xH120mm)

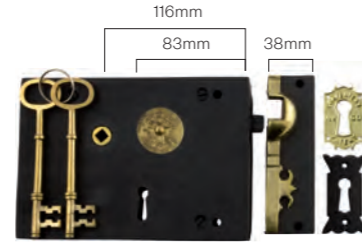

2005 LH AF
(W182xH128mm)

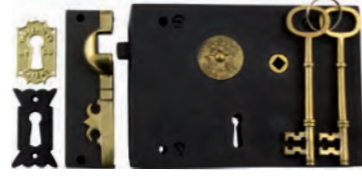

2006 RH AF
(W182xH128mm)

Spare Keepers



2017 - K



2018 - K



2005 - K



2006 - K

Screen Door Latches

Left Hand

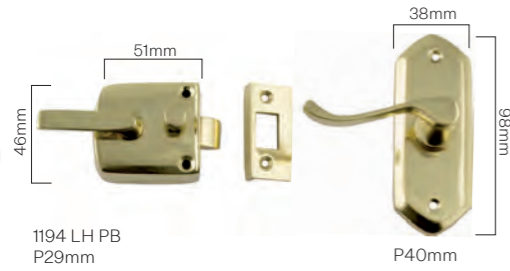

1194 LH PB
P29mm



2062 LH AC
P29mm



9636 LH MB
P29mm



2060 LH SC
P29mm

Right Hand



1193 RH PB



2061 RH AC



9637 RH MB



2059 RH SC

Box Keepers

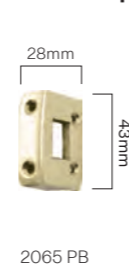

2065 PB



2066 AC



9638 MB



2068 SC

French Door Fasteners

Teardrop (P31xBP29x54mm DR95mm)



1170 PB



2206 AB



1183 AC



6466 MB



1187 CP



1172 SC

Square (P31xBP29x54mm DR95mm)



6460 PB



6461 AB



6462 AC



6465 MB



6463 CP



6464 SC



6465 MB • Square French Door Fastener • Page 63

Hinges

Fixed Pin



2474 PB
21373 UPB
(W100xH100xT3mm)



2473 PB
21372 UPB
(W75xH100xT3mm)



2472 PB
(W60xH100xT2.5mm)



2470 PB
(W50xH89xT2.5mm)



2824 SB
21375 USB
(W100xH100xT3mm)



2823 SB
21374 USB
(W75xH100xT3mm)



2822 SB
(W60xH100xT2.5mm)



3664 SB
(W50xH89xT2.5mm)



2374 AB
(W100xH100xT3mm)



2373 AB
(W75xH100xT3mm)



2372 AB
(W60xH100xT2.5mm)



2370 AB
(W50xH89xT2.5mm)



2574 AC
(W100xH100xT3mm)



2573 AC
(W75xH100xT3mm)



2572 AC
(W60xH100xT2.5mm)



2570 AC
(W50xH89xT2.5mm)



2974 MB
(W100xH100xT3mm)



2973 MB
(W75xH100xT3mm)



2972 MB
(W60xH100xT2.5mm)



2970 MB
(W50xH89xT2.5mm)

Hinges

Fixed Pin



2674 CP
(W100xH100xT3mm)



2673 CP
(W75xH100xT3mm)



2672 CP
(W60xH100xT2.5mm)



2670 CP
(W50xH89xT2.5mm)



2774 SC
(W100xH100xT3mm)



2773 SC
(W75xH100xT3mm)



2772 SC
(W60xH100xT2.5mm)



2770 SC
(W50xH89xT2.5mm)



2524 RN
(W100xH100xT3mm)



2523 RN
(W75xH100xT3mm)



2522 RN
(W60xH100xT2.5mm)



2520 RN
(W50xH89xT2.5mm)



2624 PN
(W100xH100xT3mm)



2623 PN
(W75xH100xT3mm)



2622 PN
(W60xH100xT2.5mm)



2620 PN
(W50xH89xT2.5mm)



2724 SN
(W100xH100xT3mm)



2723 SN
(W75xH100xT3mm)



2722 SN
(W60xH100xT2.5mm)



2720 SN
(W50xH89xT2.5mm)

Hinges

Ball Bearing



2464 PB
(W100xH100xT3mm)

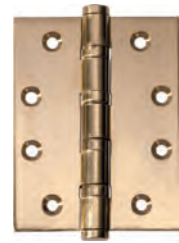

2463 PB
(W75xH100xT3mm)



2814 SB
(W100xH100xT3mm)



2813 SB
(W75xH100xT3mm)



2364 AB
(W100xH100xT3mm)



2363 AB
(W75xH100xT3mm)



2564 AC
(W100xH100xT3mm)



2563 AC
(W75xH100xT3mm)



2969 MB
(W100xH100xT3mm)



2968 MB
(W75xH100xT3mm)



2664 CP
(W100xH100xT3mm)



2663 CP
(W75xH100xT3mm)



2764 SC
(W100xH100xT3mm)



2763 SC
(W75xH100xT3mm)



2514 RN
(W100xH100xT3mm)



2513 RN
(W75xH100xT3mm)



2614 PN
(W100xH100xT3mm)



2613 PN
(W75xH100xT3mm)



2714 SN
(W100xH100xT3mm)



2713 SN
(W75xH100xT3mm)

Hinges

Hirline



2497 PB
(W49xH100xT2.5mm)



2498 PB
(W35xH89xT2mm)



2847 SB
(W49xH100xT2.5mm)



2848 SB
(W35xH89xT2mm)



2397 AB
(W49xH100xT2.5mm)



2398 AB
(W35xH89xT2mm)



2597 AC
(W49xH100xT2.5mm)



2598 AC
(W35xH89xT2mm)



2997 MB
(W49xH100xT2.5mm)



2998 MB
(W35xH89xT2mm)



2697 CP
(W49xH100xT2.5mm)



2698 CP
(W35xH89xT2mm)



2797 SC
(W49xH100xT2.5mm)



2798 SC
(W35xH89xT2mm)

Hinges

Loose Pin (W75xH100xT3mm)

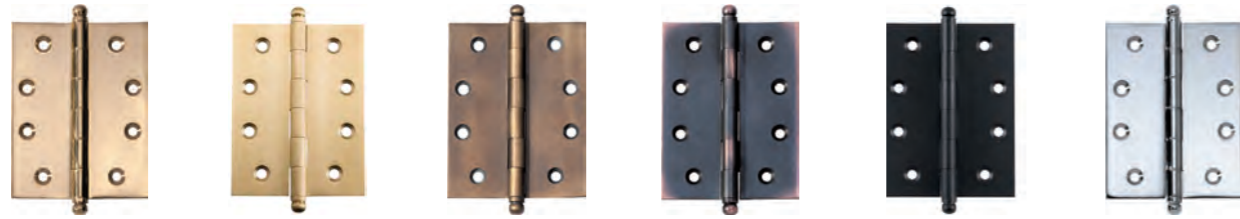

2478 PB 2828 SB 2378 AB 2578 AC 2978 MB 2678 CP



2778 SC 2528 RN 2628 PN 2728 SN

Hinges are supplied with matching stainless-steel screws, solid brass screws are also available on Page 114.



Hinges

Lift Off (W75xH100xT2.5mm)

See technical specifications on Page 147 for clarification of left and right hand lift off hinges.

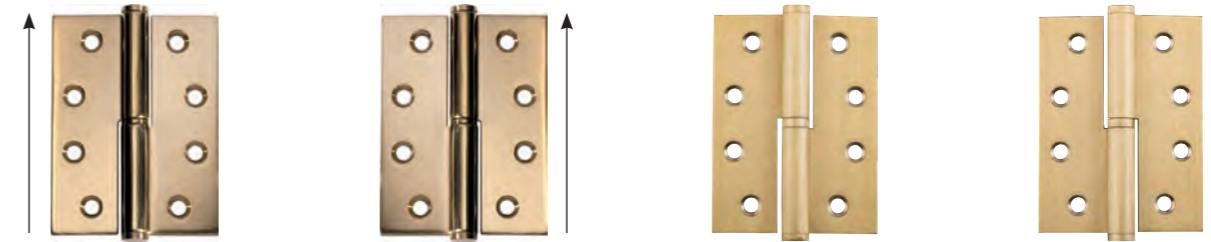

2496 LH PB 2495 RH PB 2846 LH SB 2845 RH SB



2396 LH AB 2395 RH AB 2596 LH AC 2595 RH AC



2996 LH MB 2995 RH MB 2696 LH CP 2695 RH CP



2746 LH SN 2745 RH SN

Cast Iron



1241 MB (W75xH100xT6mm) 1240 MB (W65xH89xT6mm)

Hinges are supplied with matching stainless-steel screws, solid brass screws are also available on Page 114.

Hinges

Broad Butt



2493 PB
(W200xH100xT4mm)



2492 PB
(W175xH100xT4mm)



2491 PB
(W150xH100xT4mm)



2490 PB
(W125xH100xT4mm)



4504 SB
(W150xH100xT4mm)



3681 SB
(W125xH100xT4mm)



2393 AB
(W200xH100xT4mm)



2392 AB
(W175xH100xT4mm)



2391 AB
(W150xH100xT4mm)



2390 AB
(W125xH100xT4mm)

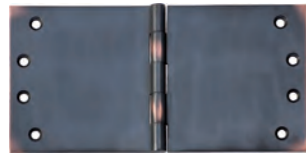

2593 AC
(W200xH100xT4mm)



2592 AC
(W175xH100xT4mm)



2591 AC
(W150xH100xT4mm)



2590 AC
(W125xH100xT4mm)



2993 MB
(W200xH100xT4mm)



2992 MB
(W175xH100xT4mm)



2991 MB
(W150xH100xT4mm)



2990 MB
(W125xH100xT4mm)



2693 CP
(W200xH100xT4mm)



2692 CP
(W175xH100xT4mm)



2691 CP
(W150xH100xT4mm)



2690 CP
(W125xH100xT4mm)



2793 SC
(W200xH100xT4mm)



2792 SC
(W175xH100xT4mm)



2791 SC
(W150xH100xT4mm)



2790 SC
(W125xH100xT4mm)

Hinges

Parliament



2484 PB
(W200xH100xT4mm)



2482 PB
(W150xH100xT4mm)

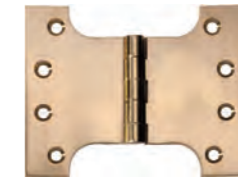

2481 PB
(W125xH100xT4mm)



2480 PB
(W100xH100xT4mm)



2384 AB
(W200xH100xT4mm)



2382 AB
(W150xH100xT4mm)



2381 AB
(W125xH100xT4mm)



2380 AB
(W100xH100xT4mm)



2584 AC
(W200xH100xT4mm)



2582 AC
(W150xH100xT4mm)



2581 AC
(W125xH100xT4mm)



2580 AC
(W100xH100xT4mm)



2984 MB
(W200xH100xT4mm)



2982 MB
(W150xH100xT4mm)



2981 MB
(W125xH100xT4mm)



2980 MB
(W100xH100xT4mm)



2684 CP
(W200xH100xT4mm)



2682 CP
(W150xH100xT4mm)

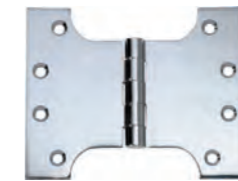

2681 CP
(W125xH100xT4mm)



2680 CP
(W100xH100xT4mm)



2784 SC
(W200xH100xT4mm)



2782 SC
(W150xH100xT4mm)



2781 SC
(W125xH100xT4mm)



2780 SC
(W100xH100xT4mm)



A. 0959 MB • Victorian Door Knob • Page 35
B. 1938 MB • Barrel Bolt • Page 79
Featured in: @thepict_birmaburra
Image Credit: Abbie Melle / @Abbie_melle



A.

B.

Window Fittings & Bolts

Bolts	74
Casement Window Stays	83
Quadrant Stays	86
Casement Window Fasteners	87
Fanlight Window Fittings	91
Hopper Window Fittings	92
Sash Window Fasteners	93
Sash Window Lifts	95
Sash Window Pulleys & Drops	97



Scan to explore our collection of Window Fittings & Bolts

Bolts

Locking Surface Mounted • Zinc Alloy
(W32xH150xP35mm • Bolt: Diameter 10mm, Throw 24mm)



1335 PVD 2248 AB 1336 AC 1339 MB 1337 CP 1338 SC



A. 1382 AC • Victorian Barrel Bolt • Page 82 / B. 1509 AC • Magnetic Door Stop • Page 48
Featured in: @houseofmudandstraw
Image Credit: Hilary Walker / @hilarywalkerphotography

Bolts

Reverse Barrel
(W32xH150mm • Bolt: Diameter 9mm, Throw 30mm)

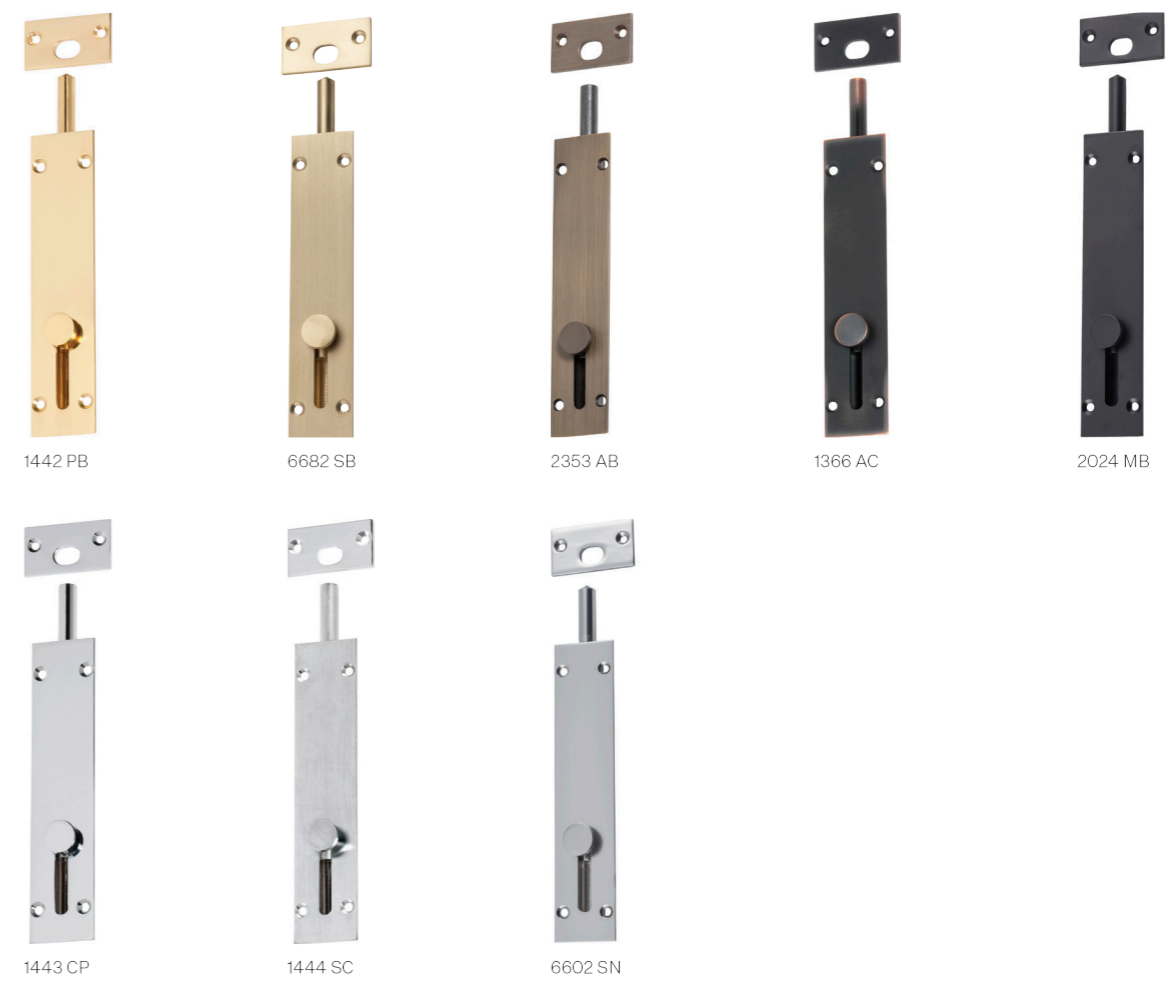

1442 PB 6682 SB 2353 AB 1366 AC 2024 MB
1443 CP 1444 SC 6602 SN

Panic
(L450mm • Bolt: Throw 47mm)



2028 PB 2029 AB 2030 AC 2035 MB 2031 CP 2033 SC

Bolts

Panic

(L255mm • Bolt: Throw 37mm)



1340 PB 2329 AB 1341 AC 1344 MB 1342 CP



1343 SC 6423 RN 6523 PN 6603 SN

Tower

(W32xL118mm • Bolt: Throw 26mm)



1445 PB 9719 AB 9742 AC 9666 MB 9754 CP 9769 SC

Bolts

Flush

(Bolt: Diameter 11mm, Throw 24mm • 2 sizes available: H150mm and H300mm)



9853 PB 1422 PB 7731 SB 7730 SB 9854 AB 2354 AB 9855 AC 1440 AC 9856 MB 2022 MB
W19xH300mm W19xH150mm W19xH300mm W19xH150mm W19xH300mm W19xH150mm W19xH300mm W19xH150mm W19xH300mm W19xH150mm



9857 CP 1441 CP 9858 SC 1439 SC 9860 RN 6421 RN 9861 PN 6521 PN 9862 SN 6601 SN
W19xH300mm W19xH150mm W19xH300mm W19xH150mm W19xH300mm W19xH150mm W19xH300mm W19xH150mm W19xH300mm W19xH150mm

Tower • Iron



1900 MB 1901 MB 1435 MB 1873 MB 1840 MB
(W55xL200mm) (W55xL300mm) (W48xL215mm) (W40xL175mm) (W48xL180mm)



A. 1014 AC • Milton Door Lever • Page 20
 B. 1381 AC • Barrel Bolt • Page 79
 Featured in @accorroseas
 Image Credit: Marnie Hawson / @marniehawson



Bolts

Barrel

(Bolt: Diameter 7.5mm, Throw 17mm, Keeper 15x25mm)

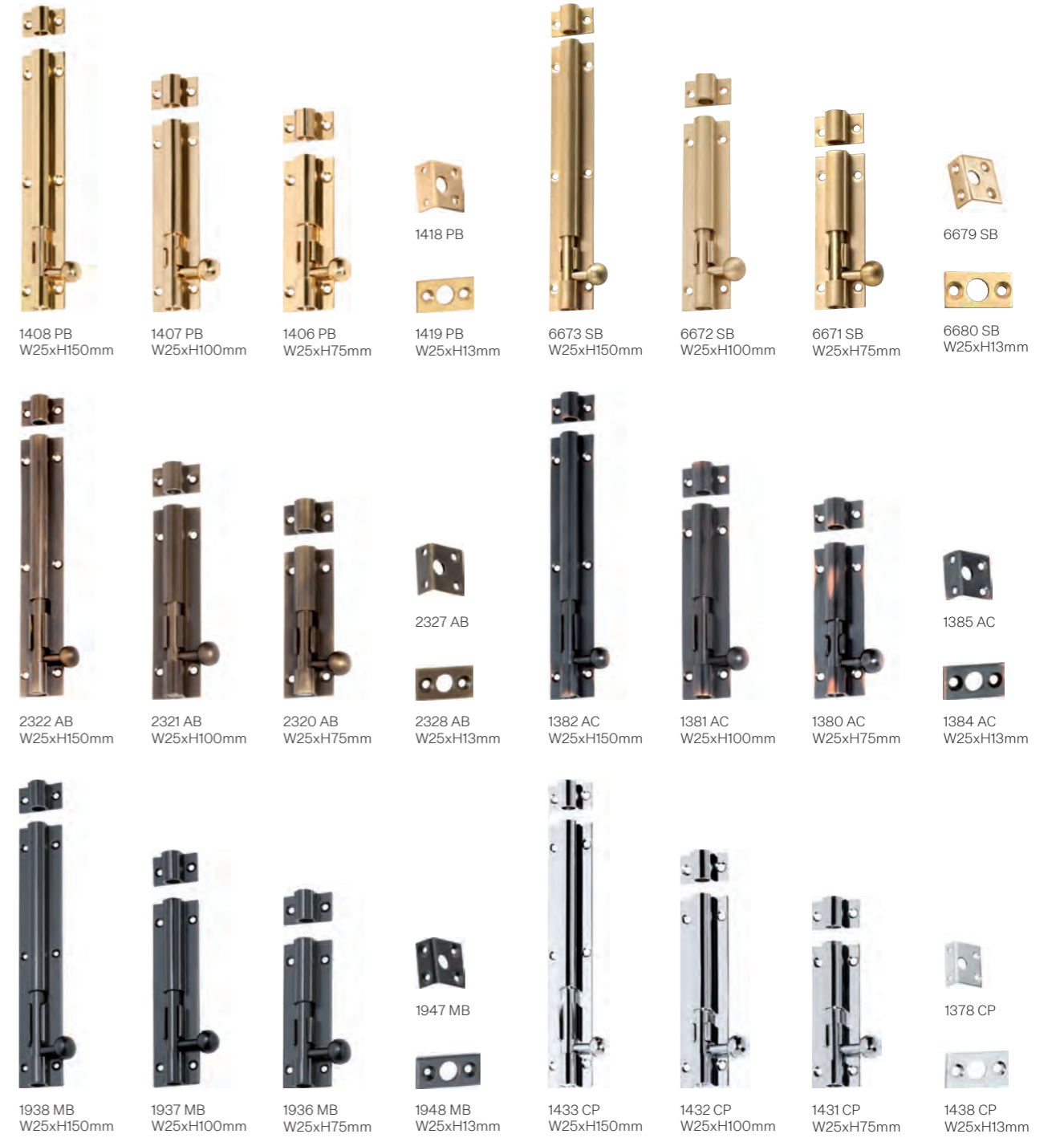

Bolts

Barrel

(Bolt: Diameter 7.5mm, Throw 17mm, Keeper 15x25mm)



Barrel Long Throw

(W25xH150mm • Bolt: Diameter 7.5mm, Long Throw 30mm, Keeper 25x13mm)



Offset

(Bolt: Diameter 7.5mm, Offset Throw 15mm, Keeper 25x13mm)



Bolts

Offset

(Bolt: Diameter 7.5mm, Offset Throw 15mm, Keeper 25x13mm)



Bolts

Victorian Barrel

(Bolt: Diameter 9mm, Throw 17mm, Keeper 32x40mm)



Victorian Barrel Long Throw

(W32xH150mm • Bolt: Diameter 9mm, Throw 30mm, Keeper 32x15mm)



Casement Window Stays

Locking Telescopic • Grade 304 Stainless Steel

L200mm OL295mm (L: closed / OL: open)



Telescopic Pin

L200mm OL295mm (L: closed / OL: open)



Telescopic Screw Down

L200mm OL295mm (L: closed / OL: open)





Casement Window Stays

Base Fix



Sidemount (L300mm)

*Shown with pin in mounted position.



Quadrant Stays

Classic
(L150mm)



1704 PB



2294 AB



1714 AC



1915 MB



1724 CP



1727 SC

Base Fix Locking Pins
(Suits 'Base Fix Casement Stays')



1766 PB



2282 AB



1767 AC



1902 MB



1768 CP



1769 SC

Casement Window Fasteners

Locking • Zinc Alloy
(W50xP34mm DR115mm)

Left hand



1770 PVD



2318 AB



1774 AC



9640 MB



1776 CP



1778 SC



9804 SN

Right Hand



1771 PVD



2319 AB



1775 AC



9641 MB



1777 CP



1779 SC



9805 SN



1741 AC • Long Throw Teardrop Casement Fastener • Page 88
Featured in: @houseofmudandstraw
Image Credit: Hilary Walker / @hilarywalkerphotography

Casement Window Fasteners

Teardrop (W40xP30mm DR95mm)



Teardrop • Long Throw (W50xP30mm DR95mm)



Teardrop Casement Fastener Spacers T6mm (To suit above)



Casement Window Fasteners

Square (W55xP30mm DR95mm)



Square Casement Fastener Spacers T6mm (To suit above)



Deco (W50xP25mm DR85mm)





Fanlight Window Fittings

Fanlight Window Operators

L900mm OL1115mm (L: closed OL: extended)

Suits inward and outward opening windows hinged at top, middle or bottom. Refer to page 150 for operating instructions.



1784 PB
Unlacquered



9714 AB
Unlacquered



1785 AC
Unlacquered



9652 MB



1787 CP



1786 SC

Fanlight Catches (W57xH50mm)



1781 PB



9715 AB



9738 AC



9653 MB



9750 CP



9765 SC

Fanlight Swivels (W23xH73mm)



1780 PB



9716 AB



9739 AC



9656 MB



9751 CP



9766 SC

Pole Hooks (ID25mm)



1782 PB



9717 AB

Fanlight Window Fittings

Fanlight Stops

L190mm (Sold as a pair)



1783 PB Pair 9718 AB Pair 9741 AC Pair 9658 MB Pair 9753 CP Pair 9768 SC Pair

Hopper Window Fittings

Hopper Window Fasteners

(L74xW39xP31mm)



1685 PB 2298 AB 1686 AC 9643 MB



1687 CP 1688 SC 9806 SN

Spur Catches

(W47xP46mm)



1737 PB 2304 AB 1747 AC 1759 MB 1757 CP 1758 SC

Wedge Fasteners

(L90xW20xP30mm)



1678 PB 2275 AB 1679 AC 9644 MB 1698 CP 1699 SC

6mm Spacers available to suit above.
1678-S PB / 2275-S AB / 1679-S AC / 9644-S MB / 1698-S CP / 1699-S SC

Sash Window Fasteners

Key Operated Locking • Zinc Alloy



1606 PVD 2307 AB 1607 AC 1837 MB 1608 CP



1609 SC 8700 SN

Key Operated Narrow Locking • Zinc Alloy



1603 EB 9863 AB 1613 AC 9864 MB 1623 CP 1624 SC

Wide Base Key Operated Locking • Zinc Alloy



20310 EB 20311 AB 20312 AC 20313 MB 20314 CP 20315 SC

Porcelain Ball



1604 PB 2301 AB 9790 PN

Sash Window Fasteners

Classic



Narrow



Sash/Sliding Window Locks • Zinc Alloy

For use as a sliding window lock, we recommend combining with our Offset pull handles (Page 44).



Sash Window Lifts

Classic (2 Sizes Available)



Dished (W45xH38xP30mm)



Reeded (W44xH40xP28mm)



Hinged (W24xH52xP18mm)



Nouveau (W35xH32xP25mm)



Sash Window Lifts

Sash Eye Offset (W49xH32xP36mm)



Bar (W63xH26xP19mm)



Stainless Steel (Phillips head screws supplied)



Sash Window Pulleys & Drops

Sash Window Pulleys • Ball bearing (W25xH125mm)

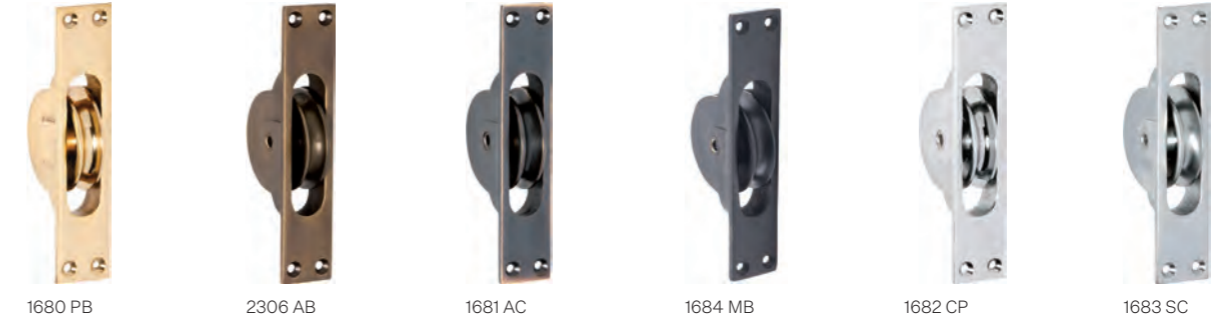

Sash Drops (H60mm)



For more information on how to install and function window hardware please refer to our window guide on Page 148.



Home Fixtures & Fittings

Traditional Bathroom Accessories	100
Hat & Coat Hooks	101
Robe Hooks	104
Picture Rail Hooks	106
Curtain Fittings	106
Brackets	108
Cabin Hooks	109
Iron Gate Accessories	110
Numerals	111
Letter Plates	111
Door Bells	111
Screws & Tie Bolts	114



Scan to explore our collection of Home Fixtures & Fittings

Traditional Bathroom Accessories

Luggage Racks 'NSWR' (L725xH240xP300mm)



4840 PB

4841 AB

4845 CP

Toilet Roll Holders



4882 PB British
W120xH150mm



4883 PB Victoria
W120xH150mm



4884 PB Coat of Arms
W120xH190mm



4880 PB Albany
W140xH195mm



4867 CP British
W120xH150mm



4868 CP Victoria
W120xH150mm



4869 CP Coat of Arms
W120xH190mm



4890 PM Iron Albany
W140xH195mm

Hat & Coat Hooks

Victorian (H110xP50mm)



3921 PB



6702 SB



3960 AB



3926 AC



9702 MB



3961 CP



3987 SC



6622 SN

Victorian (Large)



3920 PB
H125xP70mm

Federation (H95xP70mm)



3900 PB



3959 AB



3910 AC

Nouveau (H115xP80mm)



3901 PB



3911 AC

Edwardian (H145xP95mm)



3930 PB



3940 MB (Iron)



3950 PM (Iron)

Acorn (H150xP95mm)



3941 MB (Iron)



3951 PM (Iron)

Old English (H145xP85mm)



1885 MB (Iron)



A. 3960 AB • Victorian Hat & Coat Hook • Page 101
 B. 3551 CP • Classic Drawer Pull • Page 135
 Interior Design: @genninoadesign
 Image Credit: Marnie Hawson / @marniehawson



Hat & Coat Hooks

Porcelain Tip (H115xP75mm)



3970 PB 6705 SB 3972 AB 3980 AC 9703 MB



3978 CP 3979 SC

Porcelain Tip Rope (H160xP120mm)



3971 PB 3981 AC

Porcelain Tip Traditional (H175xP85mm)



3983 AB

Circular End (H115xP90mm)



3944 MB (Iron) 3954 PM (Iron)

Victorian Iron (H145xP100mm)



3943 MB (Iron) 3953 PM (Iron)

Retro (H85xP90mm)



4031 AC 4032 CP

Iron (H130xP70mm)



1887 MB

Deco (H105xP85mm)



4021 AC 4022 CP

Robe Hooks

Single Oval Backplate (H50xP42mm)



3923 PB



3963 AB



3937 AC



3938 CP



3939 SC

Single (H45xP42mm)



3924 PB



6703 SB



3935 AB



3936 AC



9704 MB



3964 CP



3988 SC

Double (W75xP30mm)



3925 PB



6704 SB



4040 AB



4041 AC



9706 MB



4042 CP



4043 SC

Robe Hooks

Acorn (H45xP70mm)



3948 MB (Iron)



3958 PM (Iron)

Old English (H50xP65mm)



1880 MB (Iron)

Deco (H45xP45mm)



4026 AC



4027 CP

Porcelain Tip Rope (H60xP75mm)



3975 PB



3985 AC

Porcelain Tip (H45xP70mm)



3976 PB



6706 SB



3977 AB



3986 AC



9705 MB



3982 CP



3984 SC

Picture Rail Hooks

Standard • Sheet Brass
(W33xH50mm)



1550 PB 1546 AC 1547 CP

Fluted • Sheet Brass
(W33xH50mm)



1551 PB 1556 AC 1555 CP

Curtain Fittings

Cleat Hooks
(H75xP20mm)



3965 PB 9816 AB 3967 AC 9683 MB 3973 CP 3974 SC

Cord Weights
(H32mm)



4650 PB 4658 AB 4655 AC 9684 MB 4656 CP 4657 SC

Sweeps



Leaf • 4640 PB (L170mm)

Ornate • 4641 PB (L175mm)

Floral • 4642 PB (L170mm)

Curtain Fittings

Centre/End Brackets



4600 PB
19mm end 4601 PB
19mm centre

Hooks/Tie Backs
(Ornate)



4646 PB
P70mm

Curtain Rings



4632 PB
ID38mm
4631 PB
ID32mm
4630 PB
ID25mm

Standard Tie Back Hooks



3907 PB P45mm 9815 AB P45mm 3917 AC P45mm 9682 MB P45mm 3903 CP P45mm



3904 SC P45mm 3913 PB P40mm 3912 PB P33mm

Reeded
(H40xP75mm)



3905 PB 3915 AC

Fleur-de-Lis
(H75xP30mm)



3906 PB 3916 AC

Finials
(Suits 19mm rod)



4611 PB
Porcelain Fluted

4612 PB
Acorn

Brackets

Planter Hook (H125xP250mm)



1539 MB (Iron)

Shelf



1542 PB
H200xP200mm
1541 PB
H150xP150mm
1540 PB
H130xP130mm



1942 MB (Iron)
H200xP200mm
1941 MB (Iron)
H150xP150mm
1940 MB (Iron)
H130xP130mm

Victorian Shelf



20376 MB
H205xP250mm

Ornate Shelf (H80xP100mm)



1543 PB



1544 MB (Iron)

Handrail Bracket (P75mm BPD56mm)



1545 PB



1596 SC



Cabin Hooks

Cabin Hooks (Available in 2 sizes)

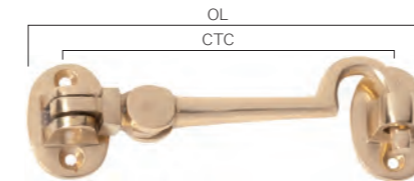

1518 PB
OL175mm CTC150mm



2356 AB
OL175mm CTC150mm



1519 AC
OL175mm CTC150mm



1516 PB
OL120mm CTC100mm



2355 AB
OL120mm CTC100mm



1517 AC
OL120mm CTC100mm

9677 MB
OL175mm CTC150mm

9676 MB
OL120mm CTC100mm

1529 SC
OL175mm CTC150mm



1870 MB (Iron)
OL140mm CTC100mm

1504 CP
OL175mm CTC150mm

1528 SC
OL120mm CTC100mm



Iron Gate Accessories

Slide Bolt
(L200mm)



1906 MB

Fleur-de-Lis Hinge
(L400xH100mm • Decorative only)



1850 MB

Gate Hinges



1917 MB
L300xH100mm



1852 MB
L235xH120mm

Gate Latch and Rings

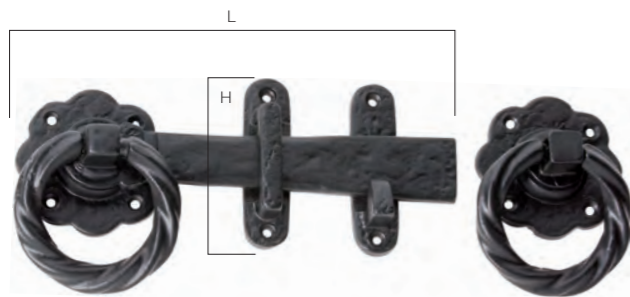

1868 MB
L200xH80mm

Ring D70mm
BPD60mm

Ring Only
(D70 BPD60mm)



1869 MB

Door Stud
(W19xH19mm)



1855 MB

Suffolk Latches

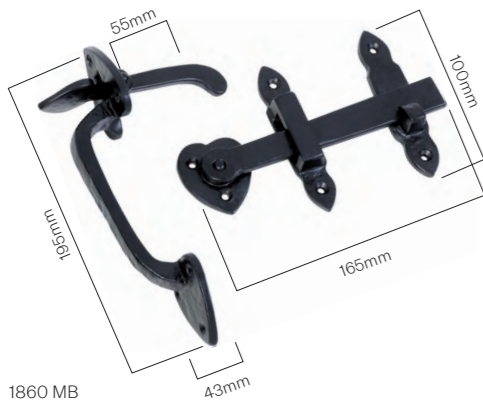

1860 MB

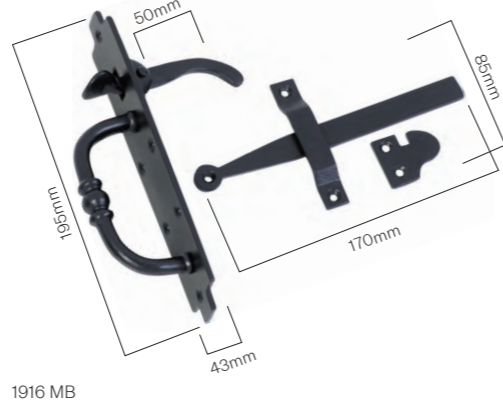

1916 MB

Numerals

Numerals • Brass
(H100mm)



0610 PB

0611 PB

0612 PB

0613 PB

0614 PB

0615 PB

0616 PB

0617 PB

0618 PB

0619 PB

Numerals • Malleable Iron
(H75mm)



1890 MB

1891 MB

1892 MB

1893 MB

1894 MB

1895 MB

1896 MB

1897 MB

1898 MB

1899 MB

Letter Plates

(L300xH100mm)



1351 PB



2368 AB



1358 AC



1949 MB



1359 CP



1360 SC

Door Bells

Plain Turn Bells
(Bell: D90mm, Turn: W43xH83mm)

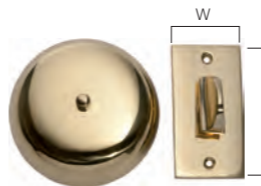

5514 PB



5515 AB



5516 AC



5519 MB



5517 CP



5518 SC

Door Bells

Ornate Turn Bells

(Bell: W92xH125mm, Turn: W42xH75mm)



5504 PB

5507 AB

5508 AC

5509 AF (Iron)

Ship's Bells • Regular
(D100mm)



1290 PB

6681 SB

2369 AB

9818 AC



1295 MB

1293 CP

9770 SC

Ship's Bells • Large
(D125mm)



1291 PB

9723 AB

9685 MB

Hand Bell
(H160xD75mm)



1294 PB

Door Bells

(Hard Wiring Required)

Bell Presses
(D75mm)



5500 PB

9724 AB

5510 AC

9686 MB



9757 CP

9771 SC

Ornate
(W90xH90mm)



5502 PB/BL

5512 PB/BL

Federation
(D63mm)



5503 PB

5513 AC

Oval
(W40xH80mm)



5501 PB/BL

5511 AC

Screws & Tie Bolts

Domed Head Screws (Solid brass, sold in packets of 50)



SCPB25 PB
L25mm
6 gauge



SCPB19 PB
L19mm
5 gauge



SCSB25 SB
L25mm
6 gauge

SCSB19 SB
L19mm
5 gauge



SCAB25 AB
L25mm
6 gauge

SCAB19 AB
L19mm
5 gauge



SCAC25 AC
L25mm
6 gauge

SCAC19 AC
L19mm
5 gauge



SCMB25 MB
L25mm
6 gauge

SCMB19 MB
L19mm
5 gauge



SCCP25 CP
L25mm
6 gauge

SCCP19 CP
L19mm
5 gauge



SCSC25 SC
L25mm
6 gauge

SCSC19 SC
L19mm
5 gauge



SCRN25 RN
L25mm
6 gauge

SCRN19 RN
L19mm
5 gauge



SCPN25 PN
L25mm
6 gauge

SCPN19 PN
L19mm
5 gauge



SCSN25 SN
L25mm
6 gauge

SCSN19 SN
L19mm
5 gauge

Hinge Screws (Solid brass and stainless-steel (SS), sold in packets of 50)



SCHINGEPB32 PB
L32mm 10 gauge
SCHINGEPB25 PB
L25mm 8 gauge
SCHINGESS32 EB
L32mm 10 gauge
SCHINGESS25 EB
L25mm 8 gauge



SCHINGESB32 SB
L32mm 10 gauge
SCHINGESB25 SB
L25mm 8 gauge
SCHINGESS32 SB
L32mm 10 gauge
SCHINGESS25 SB
L25mm 8 gauge



SCHINGEAB32 AB
L32mm 10 gauge
SCHINGEAB25 AB
L25mm 8 gauge
SCHINGESS32 AB
L32mm 10 gauge
SCHINGESS25 AB
L25mm 8 gauge



SCHINGEAC32 AC
L32mm 10 gauge
SCHINGEAC25 AC
L25mm 8 gauge
SCHINGESS32 AC
L32mm 10 gauge
SCHINGESS25 AC
L25mm 8 gauge



SCHINGEMB32 MB
L32mm 10 gauge
SCHINGEMB25 MB
L25mm 8 gauge
SCHINGESS32 MB
L32mm 10 gauge
SCHINGESS25 MB
L25mm 8 gauge



SCHINGECP32 CP
L32mm 10 gauge
SCHINGECP25 CP
L25mm 8 gauge
SCHINGESS32 CP
L32mm 10 gauge
SCHINGESS25 CP
L25mm 8 gauge



SCHINGESC32 SC
L32mm 10 gauge
SCHINGESC25 SC
L25mm 8 gauge
SCHINGESS32 SC
L32mm 10 gauge
SCHINGESS25 SC
L25mm 8 gauge



SCHINGERN32 RN
L32mm 10 gauge
SCHINGERN25 RN
L25mm 8 gauge
SCHINGESS32 RN
L32mm 10 gauge
SCHINGESS25 RN
L25mm 8 gauge



SCHINGEPN32 PN
L32mm 10 gauge
SCHINGEPN25 PN
L25mm 8 gauge
SCHINGESS32 PN
L32mm 10 gauge
SCHINGESS25 PN
L25mm 8 gauge



SCHINGESN32 SN
L32mm 10 gauge
SCHINGESN25 SN
L25mm 8 gauge
SCHINGESS32 SN
L32mm 10 gauge
SCHINGESS25 SN
L25mm 8 gauge

Tie Bolts (Solid brass, sold individually • L65mm (max. length) M4 thread)



SCTBOLTPB PB



SCTBOLTSB SB



SCTBOLTAB AB



SCTBOLTAC AC



SCTBOLTMB MB



SCTBOLTCP CP



SCTBOLTSC SC



SCTBOLTRN RN



SCTBOLTPN PN



SCTBOLTSN SN





A. 5550 & 5551 AB • Traditional Light Switches and Dimmer • Page 118
B. 5425 (Painted by owner) • Classic Switch & Socket Wood Block • Page 120
Featured in: @bunya_house_bonrai
Image Credit: Marnie Hawson / @marniehawson



Light Switches & Sockets

Period Switches & Sockets	118
Switch & Socket Wood Blocks	120
Flat Plate Switches & Sockets	122



Scan to explore our collection of Light Switches & Sockets

Period Switches & Sockets

Traditional Light Switches, Dimmers and Fan Controllers (D50xP40mm)



5474 PB 5550 AB 5674 AC 5310 MB 5774 CP 5520 SC



5475 Dimmer PB 5551 Dimmer AB 5675 Dimmer AC 5311 Dimmer MB 5775 Dimmer CP 5521 Dimmer SC
5475/250 LED Dimmer PB 5551/250 LED Dimmer AB 5675/250 LED Dimmer AC 5311/250 LED Dimmer MB 5775/250 LED Dimmer CP 5521/250 LED Dimmer SC
5495 Fan Controller PB 5552 Fan Controller AB 5695 Fan Controller AC 5312 Fan Controller MB 5795 Fan Controller CP 5522 Fan Controller SC

Traditional Sockets (D50xP30mm)



5479 PB/BR 5554 AB/BR 5679 AC/BR 5780 CP/WH 5525 SC/WH
5480 PB/WH 5555 AB/WH 5779 CP/BR 5524 SC/BR

Porcelain Base Light Switches, Dimmers and Fan Controllers (D60xP48mm)



5100 PB/IV 5101 Dimmer PB/IV 5150 PB/BL 5151 Dimmer PB/BL
5101/250 LED Dimmer PB/IV 5151/250 LED Dimmer PB/BL
5102 Fan Controller PB/IV 5152 Fan Controller PB/BL



5105 AB/IV 5106 Dimmer AB/IV 5155 AB/BL 5156 Dimmer AB/BL
5106/250 LED Dimmer AB/IV 5156/250 LED Dimmer AB/BL
5107 Fan Controller AB/IV 5157 Fan Controller AB/BL

Period Switches & Sockets

Federation Light Switches, Dimmers and Fan Controllers (D62xP38mm)



5470 PB 5560 AB 5471 AC 5320 MB 5770 CP 5530 SC



5472 Dimmer PB 5561 Dimmer AB 5473 Dimmer AC 5321 Dimmer MB 5772 Dimmer CP 5531 Dimmer SC
5472/250 LED Dimmer PB 5561/250 LED Dimmer AB 5473/250 LED Dimmer AC 5321/250 LED Dimmer MB 5772/250 LED Dimmer CP 5531/250 LED Dimmer SC
5492 Fan Controller PB 5562 Fan Controller AB 5493 Fan Controller AC 5322 Fan Controller MB 5792 Fan Controller CP 5532 Fan Controller SC

Federation Sockets (D60xP29mm)



5478 PB/WH 5564 AB/BL 5477 AC/BL 5324 MB/BL 5778 CP/WH 5535 SC/WH
5476 PB/BL 5565 AB/WH 5776 CP/BL 5534 SC/BL

Fluted Light Switches, Dimmers and Fan Controllers (D55xP40mm)



5481 PB 5570 AB 5482 AC 5330 MB 5781 CP 5540 SC



5483 Dimmer PB 5571 Dimmer AB 5484 Dimmer AC 5331 Dimmer MB 5783 Dimmer CP 5541 Dimmer SC
5483/250 LED Dimmer PB 5571/250 LED Dimmer AB 5484/250 LED Dimmer AC 5331/250 LED Dimmer MB 5783/250 LED Dimmer CP 5541/250 LED Dimmer SC
5487 Fan Controller PB 5572 Fan Controller AB 5488 Fan Controller AC 5332 Fan Controller MB 5787 Fan Controller CP 5542 Fan Controller SC

Switches are 10 AMP – 2 way. Dimmers and fan controllers are variable speed and require a switch to turn on and off. Dimmers are 400VA, suitable for most applications including low voltage downlights and incandescent lights. Important: Only dimmers with the '/250' suffix are LED compatible. Before ordering LED compatible dimmers please read carefully 'Using Tradco Dimmers with LED Lights' – available to download from our website. Please refer to your fan data specs for compatibility with HPM fan controllers.

Switch & Socket Wood Blocks

Traditional Profile

Polished blocks are 'Cedar' stain applied to MDF veneer

Raw blocks are Hoop Pine

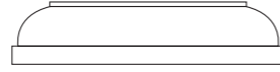

5430 D90mm
5431 W90xH90mm
5432 L155xH90mm



5440 D90mm
5441 W90xH90mm
5442 L155xH90mm



5435 W155xH155mm
5433 L225xH90mm



5445 W155xH155mm
5443 L225xH90mm



5434 L280xH90mm



5444 L280xH90mm



Classic Profile

Polished blocks are 'Cedar' stain applied to MDF veneer

Raw blocks are Hoop Pine

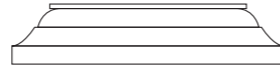

5411 W90xH90mm
5412 L155xH90mm



5421 W90xH90mm
5422 L155xH90mm



5415 W155xH155mm
5413 L225xH90mm



5425 W155xH155mm
5423 L225xH90mm



5414 L280xH90mm



5424 L280xH90mm



Flat Plate Switches & Sockets

Rocker & Toggle Switches, Sockets & Dimmer Knobs



5950 PB/WH W30xH82mm 5951 PB/WH W30xH82mm 5956 PB/WH W30xH108mm 5952 PB/WH W72xH115mm 5953 PB/WH W72xH115mm 5954 PB/WH W72xH115mm 5955 PB/WH W72xH115mm



5850 PB/WH W30xH82mm 5851 PB/WH W30xH82mm 5856 PB/WH W30xH108mm 5852 PB/WH W72xH115mm 5853 PB/WH W72xH115mm 5854 PB/WH W72xH115mm 5855 PB/WH W72xH115mm



5858 PB/WH W115xH72mm 5859 PB/WH W115xH72mm 5857 PB/WH W115xH72mm 5402 PB



5900 PB/BR W30xH82mm 5901 PB/BR W30xH82mm 5906 PB/BR W30xH108mm 5902 PB/BR W72xH115mm 5903 PB/BR W72xH115mm 5904 PB/BR W72xH115mm 5905 PB/BR W72xH115mm



5800 PB/BR W30xH82mm 5801 PB/BR W30xH82mm 5806 PB/BR W30xH108mm 5802 PB/BR W72xH115mm 5803 PB/BR W72xH115mm 5804 PB/BR W72xH115mm 5805 PB/BR W72xH115mm



5808 PB/BR W115xH72mm 5809 PB/BR W115xH72mm 5807 PB/BR W115xH72mm 5402 PB

Flat Plate Switches & Sockets

Rocker & Toggle Switches, Sockets & Dimmer Knobs



5890 AB/BR W30xH82mm 5891 AB/BR W30xH82mm 5896 AB/BR W30xH108mm 5892 AB/BR W72xH115mm 5893 AB/BR W72xH115mm 5894 AB/BR W72xH115mm 5895 AB/BR W72xH115mm



5840 AB/BR W30xH82mm 5841 AB/BR W30xH82mm 5846 AB/BR W30xH108mm 5842 AB/BR W72xH115mm 5843 AB/BR W72xH115mm 5844 AB/BR W72xH115mm 5845 AB/BR W72xH115mm



5848 AB/BR W115xH72mm 5849 AB/BR W115xH72mm 5847 AB/BR W115xH72mm 5409 AB



5910 AC/BR W30xH82mm 5911 AC/BR W30xH82mm 5916 AC/BR W30xH108mm 5912 AC/BR W72xH115mm 5913 AC/BR W72xH115mm 5914 AC/BR W72xH115mm 5915 AC/BR W72xH115mm



5810 AC/BR W30xH82mm 5811 AC/BR W30xH82mm 5816 AC/BR W30xH108mm 5812 AC/BR W72xH115mm 5813 AC/BR W72xH115mm 5814 AC/BR W72xH115mm 5815 AC/BR W72xH115mm



5818 AC/BR W115xH72mm 5819 AC/BR W115xH72mm 5817 AC/BR W115xH72mm 5404 AC



Flat Plate Switches & Sockets

Rocker & Toggle Switches, Sockets & Dimmer Knobs



Flat Plate Switches & Sockets

Rocker & Toggle Switches, Sockets & Dimmer Knobs

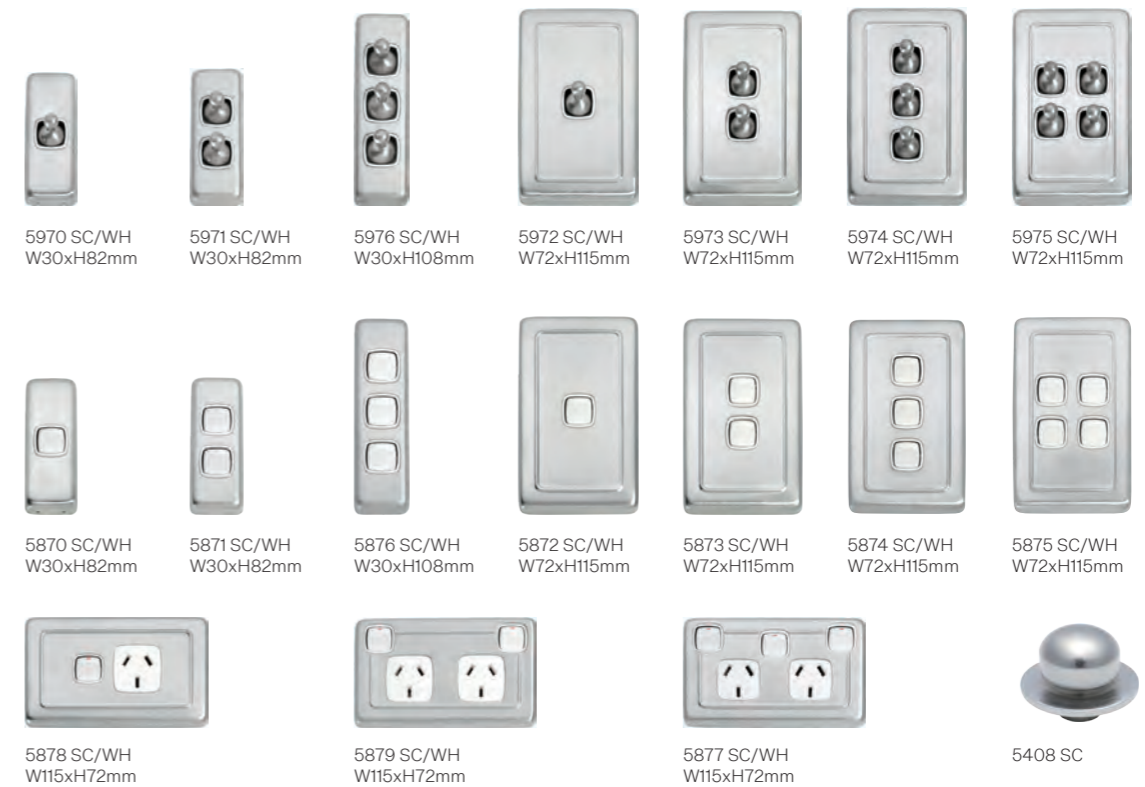



Flat Plate Switches & Sockets

Accessories are not suitable for use with power points.

Dimmers and fan controllers are variable speed and require a switch to turn on and off. Dimmers are suitable for most applications including low voltage down lights and incandescent lights.

Important: Only dimmers with the '/250' suffix are LED compatible. Before ordering LED compatible dimmers please read carefully 'Using TradCo Dimmers with LED Lights' – available to download from our website.

Standard switch mechanisms supplied are 10 AMP – 2 way, 15 and 35 AMP mechanisms are available (rocker only). 3 way intermediate rocker switches are available (to suit flat plate ranges only).

These products are ordered in addition to your TradCo switches, and will arrive unassembled.



Phone Socket
5447 WH
5446 BL



Data Socket
5021 WH
5020 BL



Digital TV Socket
5023 WH
5027 BL



Pay TV Socket
5025 WH
5028 BL



USB Fast Charging
5468 WH
5467 BL



Dimmer Unit Only
5456
5456/250 LED



Fan Controller
Unit Only
5457

Flat Plate Switch Mechanisms



Rocker mech only
5010 15 Amp BL
5026 35 Amp BL



Rocker mech only
5012 15 Amp WH
5016 35 Amp WH



Intermediate (3 way)
Rocker mech only
5029 BL



Intermediate (3 way)
Rocker mech only
5018 WH



A. 3686 AC • Domed Cupboard Knob • Page 130
B. 3568 AC • Classic Drawer Pull • Page 136
Featured in: @dunrambowral
Image Credit: Abbie Melle / @abbie_melle



Cabinet Fittings

Cupboard Knobs	130
Drawer Pulls	136
Pull Handles	139
Iron Pull Handles	140
Traditional Cabinet Handles	140
Kitchen Dresser Accessories	142
Catches, Locks & Hinges	142
Trunk Accessories	144
Castors	145



Scan to explore our collection of Cabinet Fittings

Cupboard Knobs

Classic



Domed



Domed • Iron



Cupboard Knobs

Cupboard Knob Backplates (Suits Domed Cupboard Knobs)



Flat



Curved • Small

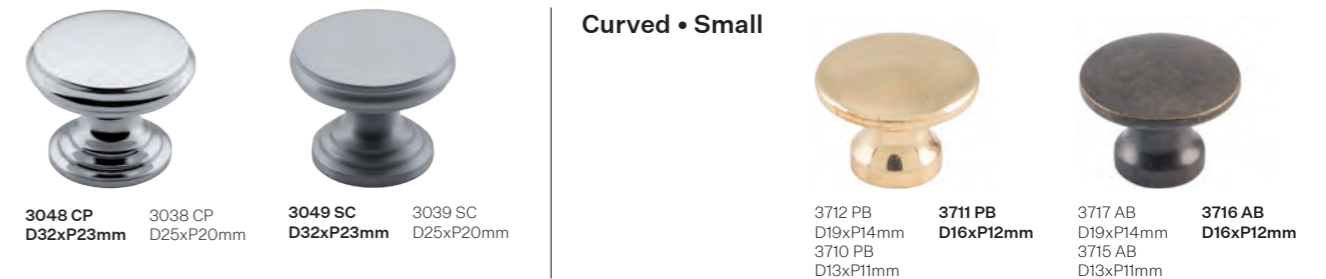



4086 MB • Octagonal Iron Cupboard Knob • Page 133
 Interior Design: Georgie Shepherd Interior Design •
 Image Credit: David Sievers / @david_sievers_photography



Cupboard Knobs

Fluted (D35xP26mm)



3675 PB



3676 AC



3045 SC

Fluted • Iron



3707 PM
D38xP42mm



3706 PM
D32xP36mm



3702 MB
D38xP42mm



3701 MB
D32xP36mm

Fluted with Backplate • Iron



3697 PM
D38xP48mm



3696 PM
D32xP44mm



3692 MB
D38xP48mm



3691 MB
D32xP44mm

Octagonal with Backplate • Iron



4086 MB
D38xP40mm
4084 MB
D25xP33mm



4085 MB
D32xP35mm

Stepped • Iron (D30xP36mm)



3700 MB

Stepped with Backplate • Iron (D30xP40mm)



3690 MB

Round • Iron



4083 MB
D38xP34mm
4081 MB
D25xP25mm

4082 MB
D32xP30mm

Victorian • Sheet Brass



3669 PB
D50xP37mm
3667 PB
D32xP26mm
3665 PB
D19xP21mm



3668 PB
D38xP29mm
3666 PB
D25xP22mm

Georgian • Sheet Brass



3674 PB
D50xP38mm
3672 PB
D32xP27mm
3670 PB
D19xP24mm



3673 PB
D38xP32mm
3671 PB
D25xP26mm

Ornate • Iron (L54xW35xP36mm)



3694 PM



3693 MB

Cupboard Knobs

Sophia Glass



9520 PB
D41xP47mm
BP27mm



9510 PB
D33xP39mm
BP26mm



9523 MB
D41xP47mm
BP27mm



9513 MB
D33xP39mm
BP26mm



9542 CP
D40xP55mm
BP28mm

Flower • Porcelain



3009 CP/WH
D50xP36mm



9514 CP
D33xP39mm
BP26mm

Porcelain



9541 CP
D30xP42mm
BP26mm



3030 CP
D38xP57xBP24mm



21043 CP/WH
D38xP36mm

Domed / Fluted • Porcelain



3011 CP/WH
D60xP38mm



21044 CP/WH
D32xP30mm

Crazed • Ivory Porcelain



21052 MB/WH
D38xP36mm



21053 CP/WH
D32xP30mm

Round • Porcelain



3476 WH
D38xP37mm
3474 WH
D25xP27mm



3475 WH
D32x33mm

Timber • Woodscrew



KSP1 Pine
D54xP39mm



KSP5 Pine
D48xP40mm



KSP2 Pine
D40xP34mm



KSP4 Pine
D40xP31mm



KSP3 Pine
D54xP34mm

KSC1 Mahogany
D54xP39mm

KSC2 Mahogany
D40xP34mm

KSC3 Mahogany
D54xP34mm

KSC4 Mahogany
D40xP31mm

*45mm Woodscrew.
(Supplied with all
woodscrew knobs.)

Drawer Pulls

Classic • Sheet Brass (L97xH40mm)



3551 PB



6711 SB



3261 AB



3561 AC



9561 MB



3581 CP



3141 SC



3137 PN



3139 SN

Fluted • Sheet Brass (L97xH40mm)



3550 PB



6710 SB



3260 AB



3560 AC



9560 MB



3580 CP



3140 SC



3136 PN



3138 SN



A. 6714 SB • Sheet Brass Cupboard Knobs • Page 130 / B. 6711 SB • Classic Sheet Brass Drawer Pull • Page 135
Featured in: @castlefieldandco
Image Credit: Roger Thompson / @roger_thompson_photography

Drawer Pulls

Classic (L100xH40mm)



3558 PB
21390 UPB



6695 SB
21397 USB



3262 AB



3568 AC



9693 MB



3569 CP



3570 SC



6435 RN



6615 SN



4080 MB (Iron)



4090 PM (Iron)



Fluted



3556 PB
L90xH40mm



3566 AC
L90xH40mm



3574 MB (Iron)
L105xH40mm



3584 PM (Iron)
L105xH40mm



3559 PB
L95xH50mm



3571 MB (Iron)
L95xH50mm



3589 PM (Iron)
L95xH50mm

Drawer Pulls

Ornate Cupped (L110xH35mm)



3552 PB



3562 AC



3572 MB (Iron)



3582 PM (Iron)

Ornate Classic (L100xH40mm)



3553 PB



3573 MB (Iron)



3583 PM (Iron)



A. 3659 CP • Sheet Brass Cupboard Knob • Page 130 / B. 3581 CP • Sheet Brass Drawer Pull • Page 135
Design by: @geninenoakesdesign
Image Credit: Marnie Hawson / @marniehawson



A. 21048 MB • Porcelain Drop Handle • Page 139
 B. 9564 MB • Sheet Brass Cupboard Knob • Page 130
 Design: Indah Island (Natalee Bowen)



Pull Handles

Porcelain 'T' Pulls • Brass (L75xP42mm)



21041 CP/WH 21050 MB/WH 21032 AB/WH

Porcelain 'D' Pulls • Brass (Available in 3 sizes)



21045 CP/WH CTC256mm 21046 CP/WH CTC192mm 21054 MB/WH CTC256mm 21055 MB/WH CTC192mm 21036 AB/WH CTC256mm 21037 AB/WH CTC192mm
 21047 CP/WH CTC128mm 21056 MB/WH CTC128mm 21038 AB/WH CTC128mm

Porcelain Drops • Brass (Available in 2 sizes)



21039 CP/WH CTC256mm 21040 CP/WH CTC160mm 21048 MB/WH CTC256mm 21049 MB/WH CTC160mm 21030 AB/WH CTC256mm 21031 AB/WH CTC160mm See matching Porcelain Cupboard Knobs on Page 134.

Deco



3444 PB L125xW20xP25mm
3447 PB L85xW20xP27mm
 3445 AC L125xW20xP25mm
3448 AC L85xW20xP27mm
 3446 CP L125xW20xP25mm
3449 CP L85xW20xP27mm

Stepped (L102xW18xP28mm)



3898 AC 3899 CP

Mid Century • Ivory Plastic/Chrome Plated



3106 CP/IV L130xW20xP29mm 3107 CP/IV L110xW17xP24mm

Iron Pull Handles

Wire Twist Pulls



3081 MB
L75xP48mm

3082 MB
L65xP37mm

Wire Twist 'D' Pull



3087 MB
L200xP70mm
1848 MB
L85xP48mm

1863 MB
L125xP50mm

Iron Twist Pulls



3060 MB
L187xP39mm

3062 MB
L145xP39mm

Fleur-de-Lis Pulls



1864 MB
L125xP29mm

1861 MB
L110xP21mm

Traditional Cabinet Handles

Classic Teardrop



3606 PB
BP32mm
DR50mm



3203 AB
BP32mm
DR50mm

Crazed Teardrop • Ivory Porcelain



3040 AB/IV
BP18mm
DR65mm

Victorian Cabinet Handles



3400 PB
L98xH43mm

3401 PB
L83xH42mm

Iron Ring Pull Bolt



3645 MB
D45mm

3588 MB
D38mm

Stepped Iron Ring Pulls



3644 MB
D38xBP35mm

Square Iron Ring Pulls



3640 MB
BP50x50mm

Maple Leaf Cabinet Handles



3405 PB
L88xH45mm

3406 PB
L70xH40mm



3205 AB
L88xH45mm

3206 AB
L70xH40mm



3425 AC
L88xH45mm

3426 AC
L70xH40mm

Swan Neck (CTC80mm)



3450 PB

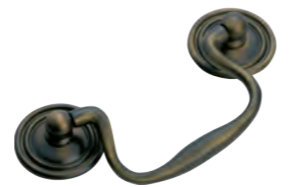

3455 AB

Traditional Cabinet Handles

Edwardian Cabinet Handles



3320 PB
L120xH55mm
3322 PB
L65xH30mm

3321 PB
L100xH48mm



3220 AB
L120xH55mm
3222 AB
L65xH30mm

3221 AB
L100xH48mm



3325 AC
L120xH55mm
3327 AC
L65xH30mm

3326 AC
L100xH48mm

Nouveau Cabinet Handles



3390 PB
L120xH65mm
3392 PB
L66xH35mm

3391 PB
L95xH50mm



3290 AB
L120xH65mm
3292 AB
L66xH35mm

3291 AB
L95xH50mm



3395 AC
L120xH65mm
3397 AC
L66xH35mm

3396 AC
L95xH50mm

Nouveau Pedestal Handles (W30xH100mm)



3394 PB



3294 AB



3399 AC

Maple Leaf Pedestal Handles (W20xH78mm)



3407 PB



3207 AB



3427 AC

Edwardian Stepped Pedestal Handles (W30xH100mm)



3323 PB



3223 AB



3328 AC

Kitchen Dresser Accessories

Kitchen Dresser Latches (10mm offset)



3831 PB Left Hand 3832 PB Right Hand



3841 AC Left Hand 3842 AC Right Hand



3843 SN Left Hand 3844 SN Right Hand

Square Offset Hinges (W50xH30mm - 10mm offset)



3767 PB 3777 AC 3797 SN

Deco Offset Hinges (W63xH32mm - 10mm offset)



3768 PB 3778 AC 3798 SN

Fold Over Cabinet Hinges (W45xH42mm - 10mm offset)



3769 PB 3779 AC 3799 SN

Catches, Locks & Hinges

Fixed Pin Cabinet Hinges



3754 PB W41xH76mm 3753 PB W35xH63mm 3752 PB W28xH50mm 3751 PB W22xH38mm 3750 PB W22xH25mm



9730 AB W41xH76mm 9729 AB W35xH63mm 9728 AB W28xH50mm 9727 AB W22xH38mm 9726 AB W22xH25mm



3794 AC W41xH76mm 3793 AC W35xH63mm 3792 AC W28xH50mm 3744 AC W22xH38mm 3743 AC W22xH25mm



9698 MB W41xH76mm 9697 MB W35xH63mm 9696 MB W28xH50mm 9695 MB W22xH38mm 9694 MB W22xH25mm



3114 CP W41xH76mm 3113 CP W35xH63mm 3112 CP W28xH50mm 3111 CP W22xH38mm 3110 CP W22xH25mm



3124 SC W41xH76mm 3123 SC W35xH63mm 3122 SC W28xH50mm 3121 SC W22xH38mm 3120 SC W22xH25mm



Catches, Locks & Hinges

Thumb Turns (W28xH40xP27mm)



3802 PB 3807 AC

Butterfly Catches (L45mm)



3810 PB 3811 AF (Iron)

Deco Push Button Catch (P29xBP39mm)



3103 CP
D50xP36mm

Catches, Locks & Hinges

Cupboard Locks



4003 PB
W37xH76mm
4001 PB
W26xH51mm

4002 PB
W32xH63mm
4000 PB
W20xH38mm

Drawer/Till Locks

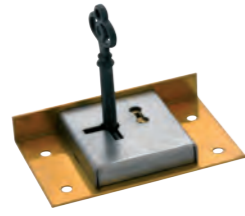

4007 PB
W76xH48mm
4005 PB
W51xH38mm

4006 PB
W63xH48mm
4004 PB
W38xH32mm



4012 Spare Key
Suits cupboard and drawer/till locks.
Please specify lock when ordering.

Cupboard Escutcheons



3804 PB
D19mm



3827 AB
W40xH30mm



3818 PB
D23mm



3829 AB
D23mm



3828 AC
D23mm



3819 PB
W16xH28mm



3812 AB
W16xH28mm



3813 AC
W16xH28mm

Trunk Accessories

Iron Hinges



3785 MB
L100xW22xH68mm
3749 MB
L70xW21xH55mm



3788 MB
L300xW28xH93mm
3787 MB
L195xW26xH80mm
3786 MB
L150xW24xH72mm



1853 MB
L165xH35mm



3791 MB (Iron)
W63xH38mm

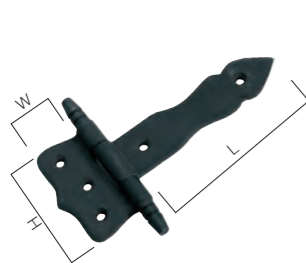

3790 MB
L90xW39xH58mm

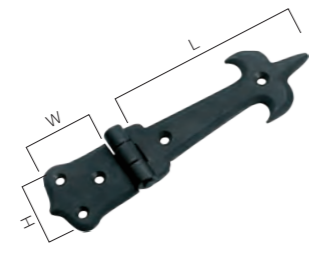

3789 MB
L94xW50xH38mm

Trunk Accessories

Trunk Handles (L120xH68mm)



3851 PB



3870 MB (Iron)

Box Corners



3861 PB
L47xW47xH40mm

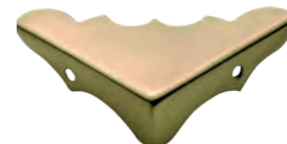

3862 PB
L45xW45xH15mm

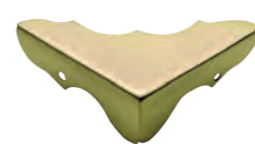

3863 PB
L32xW32xH12mm

Castors

Screw Plate • Brass Wheel



3523 PB
D38mm
3520 PB
D25mm

3522 PB
D32mm

Screw Plate • Porcelain Wheel



3507 PB/WH
D38mm
3504 PB/WH
D25mm

3506 PB/WH
D32mm



3503 PB/BR
D38mm
3500 PB/BR
D25mm

3502 PB/BR
D32mm

Glass Cups



3546
D78mm ID54mm
3545
D65mm ID36mm

Door Lock Technical Information

Find technical information on our range of locks below.

Remember – if your door doesn't need to lock, you simply need a tube latch (Page 56) to make it function. If you are trying to replace an existing lock, simply remove it from your door, measure it and compare it with the sizes and types on our website to determine what you need.

External Doors

Key type:

- If you're after a traditional 'old style' key, choose the skeleton key¹. This key is used with a 5 lever lock.
- If you'd prefer a modern looking key, choose the euro key². These keys can be easily replicated, changed or keyed by a locksmith, and require a euro cylinder³.

Door type:

- Regular single doors with a stile 110mm or greater require a 5 lever/euro mortice lock with standard 57mm backset.
- Regular single doors with a stile 90mm or less require a 5 lever/euro mortice lock with standard 46mm backset.
- If the measurements of the stile are between the above measurements you can use either lock, however, your lock will not be centered on the door stile.
- If your double or french doors are rebated, you will require a rebated lock. The above measurements also apply to rebated locks⁴.

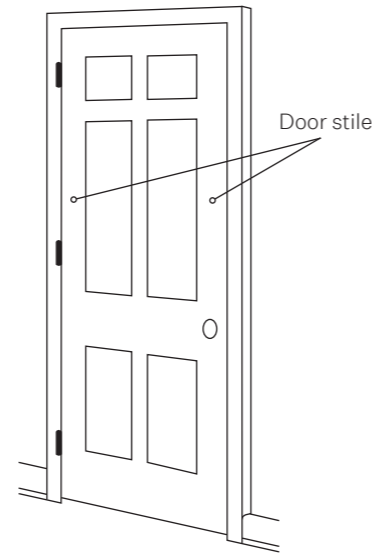

Technical Information

Find technical information on door lever handing and lift-off hinges below.

Left and Right Hand Door Levers

Determined by which hand you use to open an inward opening door. Simply add 'LH' for left hand, or 'RH' for right hand, to the end of any door furniture code when ordering half sets.

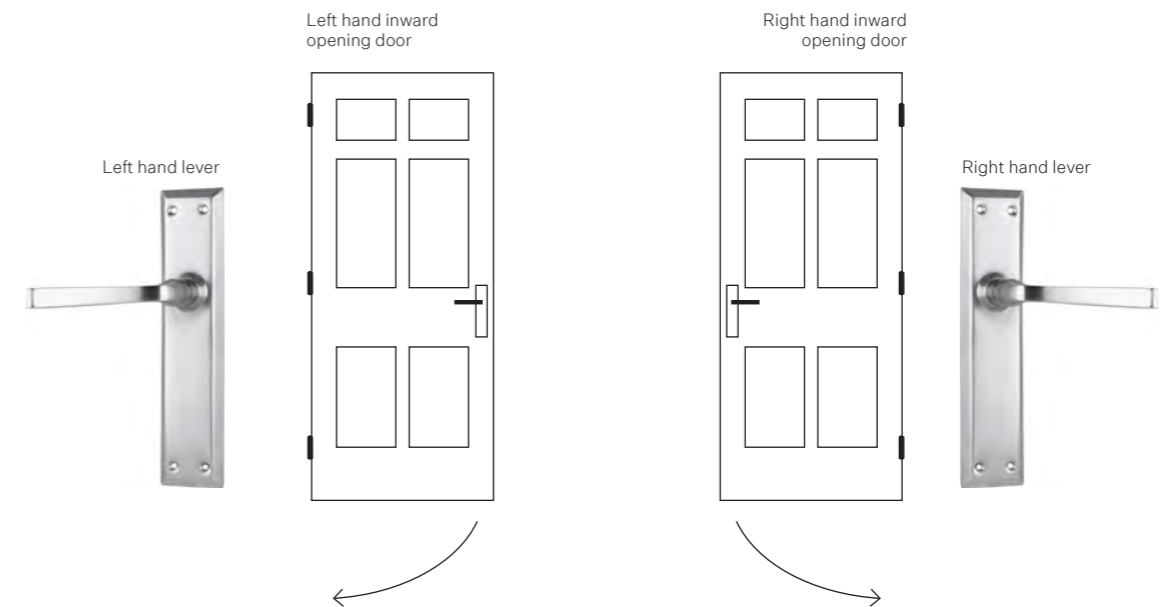

Left and Right Hand Lift-off Hinges

Lift off hinges allow a door to be removed from the outside when locked during an emergency.

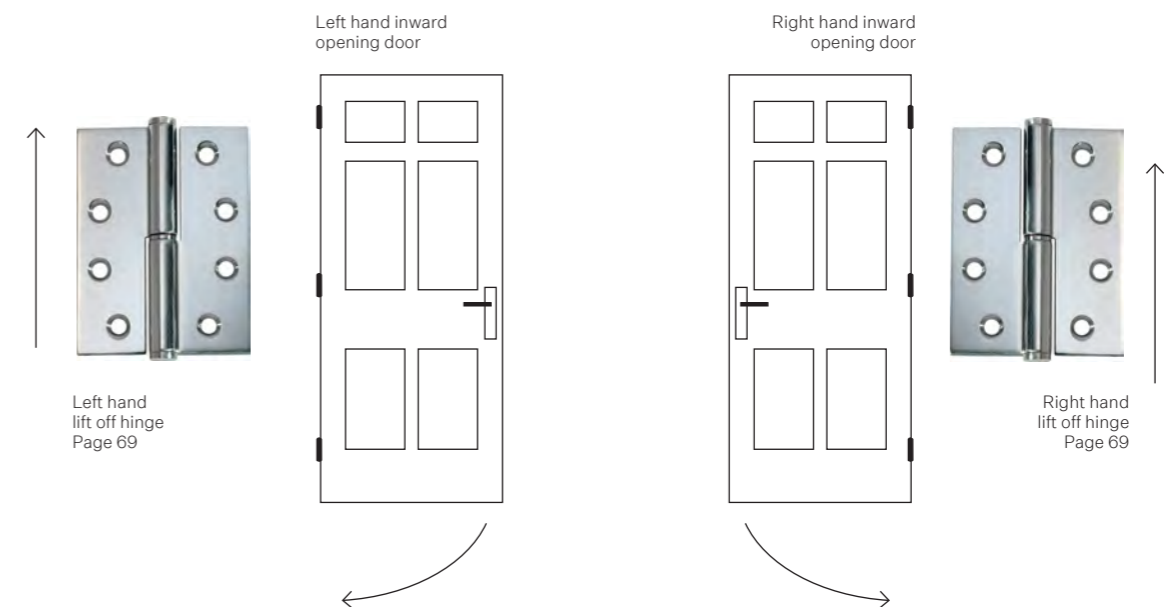

Internal Doors

Privacy:

If your door needs a thumb turn privacy function (e.g. bathroom, bedroom, toilet, etc.), there are 2 options you can choose from:

1. Long backplate privacy door furniture: you will require a privacy mortice lock⁵ with a privacy adaptor⁶ (adaptor included with all privacy door furniture).
2. Door knob / lever on rose: these products require a separate privacy bolt⁷ and privacy turn⁸.

Lock type

- If your internal door needs to lock with a key, you'll need a 3 lever mortice lock (skeleton key)⁹.
- If you have rebated double doors, a rebated 3 lever mortice lock¹⁰ is required.



Scan to discover a range of helpful resources on the TradCo website. Find installation guides, templates and videos, warranty information, digital catalogues and more.

Window Guide

All products are available in a wide range of finishes, please check catalogue or website for more details.

Casement Windows



Base Fix Casement Stays

Used to hold the window open, the "arm" is attached to the window frame and pins to the sill. Casement stays allow the window to be opened by lifting the arm and pushing out the window. The stay has holes along it so the window can be held open by using the pins located on the sill.



1708 PB

Base Fix Telescopic Casement Stay

These stays attach to the window and the window sill. When the knob is released, the window can be pushed out to the desired opening. The button or key can then be engaged at varying intervals to hold the window open.



1824 MB

Key Lockable Telescopic Stay



1674 PVD

Sidemount Casement Window Stays

These are installed on the side of the window and frame, they hold the window open in various positions and hold the window closed with the arm going into the keeper on the frame. This product eliminates the need for a casement fastener.



2314 AB

Casement Fasteners

Used to fasten the window in place when closed. Supplied with surface mounted keeper for double windows and a flat keeper for single windows.



1741 AC

1839 MB

1778 SC

9805 SN

For image reference of casement fasteners please refer to Page 87

They are also available key lockable - *Please note these are handed Left and Right.

Awning and Hopper Windows



Hopper Windows (Opens Inwards)



Awning Window (Opens Outwards)

Spur Catch

Spur catch used on awning windows. (Opens Outwards)



1757 CP



Quadrant Stays

Normally used for outward opening awning windows that are hinged on top or bottom. Can be used in conjunction with the spur catch above. A quadrant stay is used to hold the window open.



1704 PB



Quadrant Stay sequence

Hopper Window Catch

Used on hopper windows –open inwards. Supplied with both flat and surface mounted keeper. The flat keeper is for single window use and sits on the frame. The surface mounted keeper is used for hopper windows that sit flush with the frame.



9643 MB



Hopper Window Catch sequence

Window Guide

All products are available in a wide range of finishes, please check catalogue or website for more details.

Sash Windows

Single or double windows which have one fixed sash and another that slides up and down. All hardware fittings come in various finishes.

Sash Window



Sash Lifts

Used to lift the sash.



1631 PB

Sash Fasteners

Used to lock the window when closed.



1631 PB

Sash Drops

Used to hold the window open at a desired height. Swings freely when not in use.



1625 SC

*Two Sash Lifts are normally required per window.

Fanlight Windows

Fanlight windows are windows above a door, they can be hinged top, bottom or middle and open in or out.



Fanlight window operators sequence – total opening and closing solution for a fanlight window. Can be used on fanlight windows hinged at the top, middle or bottom opening inwards or outwards.



1787 CP

Fanlight Catch, Swivel and Stay & Pole Hook



Fanlight Catch

These four products are often used together for a complete fanlight window operating system.

Fanlight Catch

Suitable for fanlight windows hinged at the bottom opening inwards. Used at the top of the window.



1781 PB

Pole Hook

Attach to the end of a broomstick to open your fanlight catch.



1782 PB



Fanlight Stops

Fanlight Swivel

Two required for both sides of window. They allow the window to pivot – similar to a hinge on a door.



1780 PB

Fanlight Stop

Two required for both sides of window. Used in conjunction with a fanlight catch, the fanlight stop limits how far the window opens.



1783 PB Pair

Glossary of Terms

Awning Window

A window that is hinged at the top or bottom and swings out.

Backplate

A flat plate that an object such as a lever, knob or pull handle sits on and attaches to the door, wall or furniture. Backplates can come in many different sizes and shapes and can often be punched with a key hole.

Backset

The distance from the edge of the door (front of the lock or latch face plate) to the centre of the door handle/spindle hole. Standard backset sizes are 45mm or 60mm.

Barrel Bolt

A bolt which is mounted to the door face and locks into a striker plate on the door jamb/frame to hold the door closed. Barrel bolts can also be used on windows and come in a variety of different lengths.

Broad Butt Hinge

A hinge that is wider than it is tall. It allows a door or window to swing clear of the architrave and lay flat against the wall. Normally used on double or french doors.

Casement Window

A window that is hinged on the side and swings open like a door. Casement stays are used to hold these windows open. Casement fasteners hold them closed.

Centre to Centre

The vertical distance measured between the centre-points of spindle and key hole. Also used to describe the distance between bolt or screw holes on pull handles and other products.

Door Jamb

One of the two vertical timbers forming the sides of a door frame that a door closes against.

Key/Key Euro Cylinder

A cylinder that is keyed both sides and usually used on external doors in combination with a euro mortice lock.

Double Hung Window

Also called sash windows. Top and bottom sashes that slide up and down. The bottom sash slides up and down and the top sash also opens and closes.

Dummy Handle

Door knob or lever that is surface mounted to a door and does not work a latch. Dummy handles are installed using a taylor spindle or similar product that prevents the lever or knob from turning. Dummy handles are often used on linen cupboards or the secondary door in a double or french door set.

Escutcheon

A key hole cover.

Face Plate

Refers to the piece of metal that surrounds the latch tongue and/or locking bolt of the door lock.

Fanlight Window

Fanlight windows are windows above doors. These can be hinged at the top, bottom or middle and can open inwards or outwards.

Rebated Doors

Rebated double doors have a lip on the vertical edge where they meet, called a 'rebated meeting stile'. There is a primary door, which can open and close without affecting the secondary door. If the secondary door is opened, it needs to close fully into the frame before the primary door. Rebated doors create a seamless look with no gap between the doors and help in reducing drafts. A rebated lock or latch with a special shaped face plate is required to fit this type of door.

Rim Lock

A low security, old-style lock which is mounted to the surface of a door.

Rose

A round or square backplate that accommodates a door knob or lever.

Sash Window

Also called single or double hung windows. The bottom sash slides up and down and is supported internally by a pulley and weight system.

Sash Lift

A finger lift mounted to a window sash to allow it to be raised. Normally two are used per window.

Sash Fastener

Mounts to the top of the lower sash and locks into the catch which is attached to the bottom of the upper sash. This prevents the window from being opened.

Sash Pulley

Used in conjunction with sash cord and weights to allow sash windows (double or single hung) to open.

Skeleton Key

A skeleton key is an old-style key which operates a mortice or rim lock.

Spindle

A square bar to which a door knob or lever attaches. These can also be threaded to accommodate screw-on door knobs.

Spindle Hole

A square hole in a lock or latch which a spindle goes through to operate the latch tongue or mortice locking bolt.

Striker Plate

A metal plate attached to the door jamb, which houses the extended latch or locking bolt when the door is closed.

Glossary of Terms

Stile

The vertical panels of timber on the outer edges of a door or a window sash. The width is measured from the edge of the door to where the glass or panelling starts.

Taylor Spindle

A threaded spindle attached to a small backplate that is used in conjunction with a dummy door handle. The Taylor spindle is attached to the door and the dummy handle sits on it to prevent the handle from functioning.

Key/Thumb Cylinder

Incorporates a key to lock and unlock your door from the outside and a thumb turn mechanism on the inside to lock or unlock your door. Used in conjunction with a euro mortice lock.

Tubular (Tube) Latch

Installed into the edge of the door to hold the door shut when closed and is operated by a knob or lever via the spindle. TradCo tube latches are available in 45mm, 60mm or 70mm backset.

Quadrant Stay

A stay used on either awning or hopper windows to hold the window open. Two stays are normally used per window.

Measurement Abbreviations

L — Length

W — Width

H — Height

P — Projection

OL — Overall length

CTC — Centre to centre

T — Thickness

D — Diameter

BP — Backplate

ID — Internal diameter

DE — Depth

DR — Drop

Index

Symbols

3 Lever • Internal Locks 52
5 Lever • External Locks 53

A

Acorn Robe Hooks 105
Antique Copper (AC) 10
Awning and Hopper Windows 149

B

Ball Bearing Hinges 66
Balmoral Door Levers 117
Bar Pull Handles 42
Barrel Bolts 79
Barrel Long Throw Bolts 80
Bar Sash Window Lifts 96
Base Fix Casement Window Stays 85
Base Fix Locking Pins 86
Bell Presses 113
Bolts 74
Box Corners Trunk Accessories 145
Box Keepers 62
Brackets 108
Broad Butt Hinges 70
Bungalow Door Knobs 29
Butterfly Catches 142

C

Cabinet Fittings 129
Cabinet Pull Handles 139
Cabin Hooks 109
Camden Door Levers 21
Carpenters Locks • Cast Iron 62
Casement Window Fasteners 87
Casement Windows 148
Casement Window Stays 83
Cast Iron Hinges 69
Castors 145
Cellar Door Pulls 47
Centre Door Knobs 37
Chrome Plate (CP) 10
Circular End Hat & Coat Hooks 103
Classic Centre Door Knobs 37
Classic Cupboard Knobs 130
Classic Drawer Pulls 136
Classic Drawer Pulls • Sheet Brass 135
Classic Flush Pulls 47
Classic Flush Pulls • Large 47
Classic Flush Pulls • Small 47
Classic Offset Pull Handles 41
Classic Quadrant Stays 86
Classic Sash Window Fasteners 94
Classic Sash Window Lifts 95
Classic Teardrop Traditional Cabinet Handles 140
Concealed Fix Door Stops 48
Covered Escutcheons 58
Crazed Cupboard Knobs • Ivory Porcelain 134

Crazed Teardrop Cabinet Handles • Ivory Porcelain 140
Cupboard Escutcheons 144
Cupboard Knob Backplates 131
Cupboard Knobs 130
Cupboard Locks 144
Curtain Centre/End Brackets 107
Curtain Cleat Hooks 106
Curtain Cord Weights 106
Curtain Finials 107
Curtain Fittings 106
Curtain Hooks/Tie Backs 107
Curtain Rings 107
Curtain Sweeps 106
Curved Cupboard Knobs • Small 131
Cylinder Hole Pull Handles 41

D

Data Socket 127
Deco Cabinet Pull Handles 139
Deco Casement Window Fasteners 89
Deco Hat & Coat Hooks 103
Deco Offset Hinges 142
Deco Pull Handle/Knocker 42
Deco Pull Handles 42
Deco Push Button Catch 142
Deco Robe Hooks 105
Diamond Cut Glass Cupboard Knobs 134
Digital TV Socket 127
Dimmer Knobs 122
Dimmer Unit 127
Dished Sash Window Lifts 95
Domed Cupboard Knobs 130
Domed Cupboard Knobs • Iron 130
Domed Door Stops 49
Domed / Fluted Cupboard Knobs • Porcelain 134
Door Bells 111
Door Furniture 19
Door Knobs 34
Door Knobs • Sheet Brass 29
Door Knockers 39
Door Levers 20
Door Stops 48
Double Robe Hooks 104
Drawer Pulls 135
Drawer/Till Locks 144

E

Edwardian Cabinet Handles 141
Edwardian Door Knobs 30
Edwardian Door Knockers 39
Edwardian Stepped Pedestal Handles 141
Elwood Door Knobs 30
Escutcheons 58
Euro Cylinders 60
Euro Escutcheons • Sheet Brass 58
Euro • External Locks 54
Exeter Door Levers • Round Rose 27
External Doors 146
External Locks 53

Index

F

Fan Controller 127
Fanlight Catches 91
Fanlight Stops 92
Fanlight Swivels 91
Fanlight Window Fittings 91
Fanlight Window Operators 91
Fanlight Windows 150
Federation Door Bells 113
Federation Door Knockers 39
Federation Hat & Coat Hooks 101
Federation Sockets 119
Filigree Centre Door Knobs 37
Filigree Door Knobs 37
Fitzroy Door Knobs 29
Fixed Pin Cabinet Hinges 143
Fixed Pin Hinges 64
Flat Cupboard Knobs 131
Flat Plate Switches & Sockets 122
Flat Plate Switch Mechanisms 127
Fleur-de-Lis Curtain Tie Back Hooks 107
Fleur-de-Lis Pull Handles 43
Fleur-de-Lis Pulls • Iron Pull Handle 140
Flower Cupboard Knobs • Porcelain 134
Flush Bolts 77
Flush Pulls 46
Fluted Cupboard Knobs 133
Fluted Cupboard Knobs • Iron 133
Fluted Cupboard Knobs with Backplate • Iron 133
Fluted Drawer Pulls 136
Fluted Drawer Pulls • Sheet Brass 135
Fluted (Iron) Door Knobs 37
Fluted Picture Rail Hooks • Sheet Brass 106
Fold Over Cabinet Hinges 142
Fremantle Door Levers 22
French Door Fasteners 63

G

Georgian Cupboard Knobs • Sheet Brass 133
Glass Cups 145
Gloucester Iron Levers 27

H

Hand Bell 112
Handrail Bracket 108
Hard Sprung Split Cam Tube Latch 56
Hat & Coat Hooks 101
Henley Door Levers 22
Hinged Sash Window Lifts 95
Hinges 64
Hinge Screws 114
Hirline Hinges 67
Home Fixtures & Fittings 99
Hook Door Stops 48
Hopper Window Fasteners 92
Hopper Window Fittings 92

I

Internal Doors 146
Internal Locks 52
Iron Door Pull Handles 43
Iron Door Stud 110
Iron Fleur-de-Lis Hinge 110
Iron Gate Accessories 110
Iron Gate Hinges 110
Iron Gate Latch and Rings 110
Iron Hat & Coat Hooks 103
Iron Hinges Trunk Accessories 144
Iron Levers 27
Iron Pull Handles 140
Iron Ring 110
Iron Ring Pull Bolt 140
Iron Slide Bolt 110
Iron Suffolk Latches 110
Iron Twist Cabinet Pull Handles 140
Iron Twist Pull Handles 43
Iron Wire Twist Pull Handles 43

K

Kensington Door Knobs 30
Key/ Key Euro Cylinders 60
Key Operated Locking Sash Window Fasteners 93
Key Operated Narrow Locking Sash Window Fasteners 93
Key/ Thumb Turn Euro Cylinders 60
Kitchen Dresser Accessories 142
Kitchen Dresser Latches 142

L

Left and Right Hand Door Levers 147
Left and Right Hand Lift-off Hinges 147
Left Hand Screen Door Latches 62
Letter Plates 111
Lever on Rose Passage Set 12
Lever on Rose Privacy Set 12
Lift Off Hinges 69
Light Switches & Sockets 117
Lion Door Knockers 39
Locking Casement Window Fasteners (Zinc Alloy) 87
Locking Surface Mounted Bolts (Zinc Alloy) 74
Locking Telescopic Casement Window Stays 83
Locks, Latches & Hinges 51
Loose Pin Hinges 68
Luggage Racks 100

M

Magnetic Door Stops 48
Maple Leaf Pedestal Handles 141
Maple Leaf Traditional Cabinet Handles 140
Matt Black (MB) 10
Menton Door Levers • Long Backplate 26
Menton Door Levers • Square Rose 26
Mid Century Door Levers 27
Mid Century Pull Handles • Ivory Plastic/Chrome Plated 139
Milled Edged Door Knobs • Large 32

Index

M

Milled Edged Door Knobs • Small 32
Milled Edge Knob Backplates 32
Milton Door Knobs • Long Backplate 34
Milton Door Knobs • Round Rose 34
Milton Door Levers • Long Backplate 20
Milton Door Levers • Round Rose 20
Milton Push Plates 46

N

Napier Door Knobs 30
Narrow Sash Window Fasteners 94
Nouveau Cabinet Handles 141
Nouveau Door Knobs 29
Nouveau Offset Pull Handles 42
Nouveau Pressed Pedestal Handles 141
Nouveau Sash Window Lifts 95
Numerals 111
Numerals • Brass 111
Numerals • Malleable Iron 111

O

Octagonal Cupboard Knobs with Backplate • Iron 133
Offset Backplate Pull Handles 42
Offset Banded Pull Handles 44
Offset Bolts 80
Offset Pull Handles 44
Old English Robe Hooks 105
Ornate Centre Door Knobs 37
Ornate Classic Drawer Pulls 137
Ornate Cupboard Knobs • Iron 133
Ornate Cupped Drawer Pulls 137
Ornate Door Bells 113
Ornate Pull Handles 43
Ornate Shelf Brackets 108
Ornate Turn Bells 112
Oval Door Bells 113
Oval Door Stops 49
Oval Door Stop Spacers 49

P

Panic Bolts • L255mm 76
Panic Bolts • L450mm 75
Parliament Hinges 71
Passage Set 12
Pay TV Socket 127
Period Switches & Sockets 118
Phone Socket 127
Picture Rail Hooks 106
Plain Mortice Door Knobs 33
Plain Turn Bells 111
Planter Hook Brackets 108
Pole Hooks 91
Polished Nickel (PN) 11
Porcelain Ball Sash Window Fasteners 93
Porcelain Cupboard Knobs 134
Porcelain Door Knobs 35

Porcelain 'D' Pulls 139
Porcelain Drop Pull Handles 139
Porcelain Tip Hat & Coat Hooks 103
Porcelain Tip Robe Hooks 105
Porcelain Tip Rope Hat & Coat Hooks 103
Porcelain Tip Rope Robe Hooks 105
Porcelain Tip Traditional Hat & Coat Hooks 103
Porcelain 'T' Pulls 139
Pressed Escutcheons • Sheet Brass 59
Privacy Adaptors 58
Privacy Bolts 57
Privacy • Internal Locks 53
Privacy Set 12
Pull Handles 41
Push Plates 46

Q

Quadrant Stays 86

R

Rebated 3 Lever • Internal Locks 52
Rebated 5 Lever • External Locks 54
Rebated Euro • External Locks 55
Rebated Locks 12
Rebate Extension Plates 57
Rebate Kits 57
Reeded Curtain Tie Back Hooks 107
Reeded Door Knobs 35
Reeded Sash Window Lifts 95
Reeded Tie Back Hooks 107
Reims Door Levers • Long Backplate 24
Reims Door Levers • Short Backplate 24
Retro Door Levers 27
Retro Fit Door Knobs 33
Retro Hat & Coat Hooks 103
Reverse Barrel Bolts 75
Richmond Door Knobs • Long Backplate 31
Richmond Door Knobs • Short Backplate 31
Right Hand Screen Door Latches 62
Rim Locks 61
Rim Locks & Accessories 61
Ring Flush Pulls 47
Robe Hooks 104
Rocker & Toggle Switches 122
Round Cupboard Knobs • Iron 133
Round Cupboard Knobs • Porcelain 134
Round Privacy Turns 58
Rumbled Nickel (RN) 10

S

Sash Drops 97
Sash Eye Offset Window Lifts 96
Sash/Sliding Window Locks 94
Sash Window Fasteners 93
Sash Window Lifts 95
Sash Window Pulleys • Ball bearing 97
Sash Window Pulleys & Drops 97
Sash Windows 150

Index

Satin Chrome (SC) 10
Satin Nickel (SN) 11
Screen Door Latches 62
Screw Plate Castors • Brass Wheel 145
Screw Plate Castors • Porcelain Wheel 145
Screws & Tie Bolts 114
Shelf Brackets 108
Ship's Bells • Large 112
Ship's Bells • Regular 112
Sidemount Casement Window Stays 85
Single Oval Backplate Robe Hooks 104
Single Robe Hooks 104
Sockets 122
Sophia Glass Cupboard Knobs 134
Spare Keepers 62
Split Cam Tube Latches 56
Spur Catches 92
Square Casement Fastener Spacers 89
Square Casement Window Fasteners 89
Square French Door Fasteners 63
Square Iron Ring Pulls 140
Square Offset Hinges 142
Stainless Steel Sash Window Lifts 96
Standard Curtain Tie Back Hooks 107
Standard Picture Rail Hooks • Sheet Brass 106
Standard Pull Handles 44
Stepped Cupboard Knobs • Iron 133
Stepped Cupboard Knobs with Backplate • Iron 133
Stepped Iron Ring Pulls 140
Stepped Pull Handles 139
Stratford Iron Levers 27
Swan Neck Traditional Cabinet Handles 140
Swirl Glass Cupboard Knobs 134
Switch & Socket Wood Blocks 120

T

Teardrop Casement Fastener Spacers 88
Teardrop Casement Window Fasteners 88
Teardrop Casement Window Fasteners • Long Throw 88
Teardrop French Door Fasteners 63
Telephone Pull Handles 45
Telescopic Pin Casement Window Stays 83
Telescopic Screw Down Casement Window Stays 83
Thumb Turns 142
Tie Bolts 114
Timber Cupboard Knobs 134
Toilet Roll Holders 100
Tower Bolts 76
Tower Bolts • Iron 77
Traditional Bathroom Accessories 100
Traditional Cabinet Handles 140
Traditional Door Stops 48
Traditional Flush Pulls 46
Traditional Sockets 118
Traditional Switch & Socket Wood Blocks 120
Trunk Accessories 144
Trunk Handles 145
Tube Latches & Privacy Turns 56
Tube Latch Striker • Extra Long 57

U

Unlacquered Finishes 17
USB Fast Charging 127

V

Victorian Barrel Bolts 82
Victorian Barrel Long Throw Bolts 82
Victorian Cupboard Knobs • Sheet Brass 133
Victorian Cylinder Hole Pull Handles 41
Victorian Door Knobs • Long Backplate 35
Victorian Door Knobs • Round Rose 35
Victorian Door Knockers 39
Victorian Door Levers • Long Backplate 21
Victorian Door Levers • Round Rose 22
Victorian Hat & Coat Hooks 101
Victorian Hat & Coat Hooks • Large 101
Victorian Iron Hat & Coat Hooks 103
Victorian Shelf Brackets 108
Victorian Traditional Cabinet Handles 140

W

Wedge Fasteners 92
Wide Base Key Operated Locking Sash Window Fasteners 93
Window Fittings & Bolts 73
Window Guide 148
Windsor Door Levers 20
Wire Twist 'D' Pull • Iron Pull Handle 140
Wire Twist Pulls • Iron Pull Handle 140
Woodscrew 134

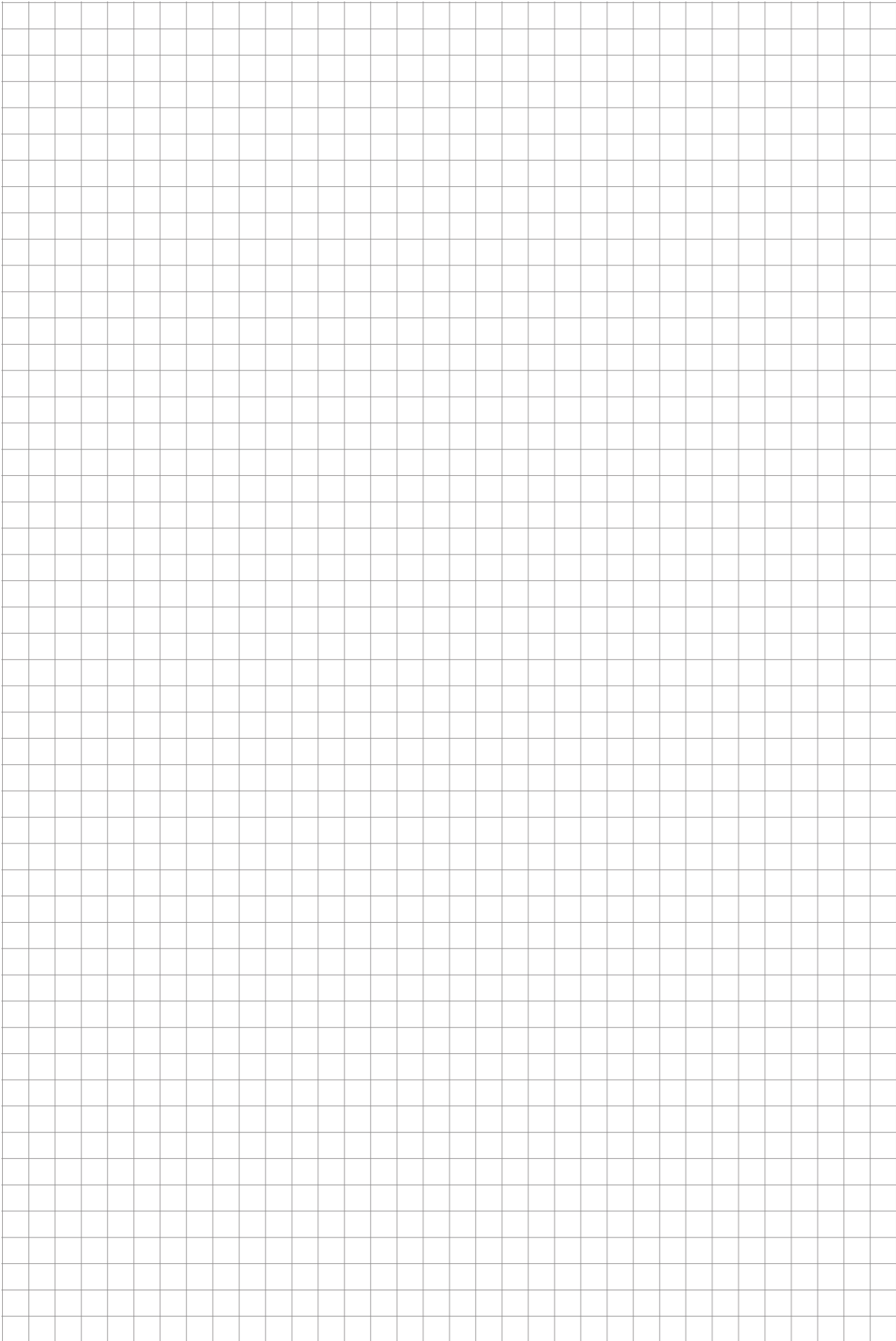

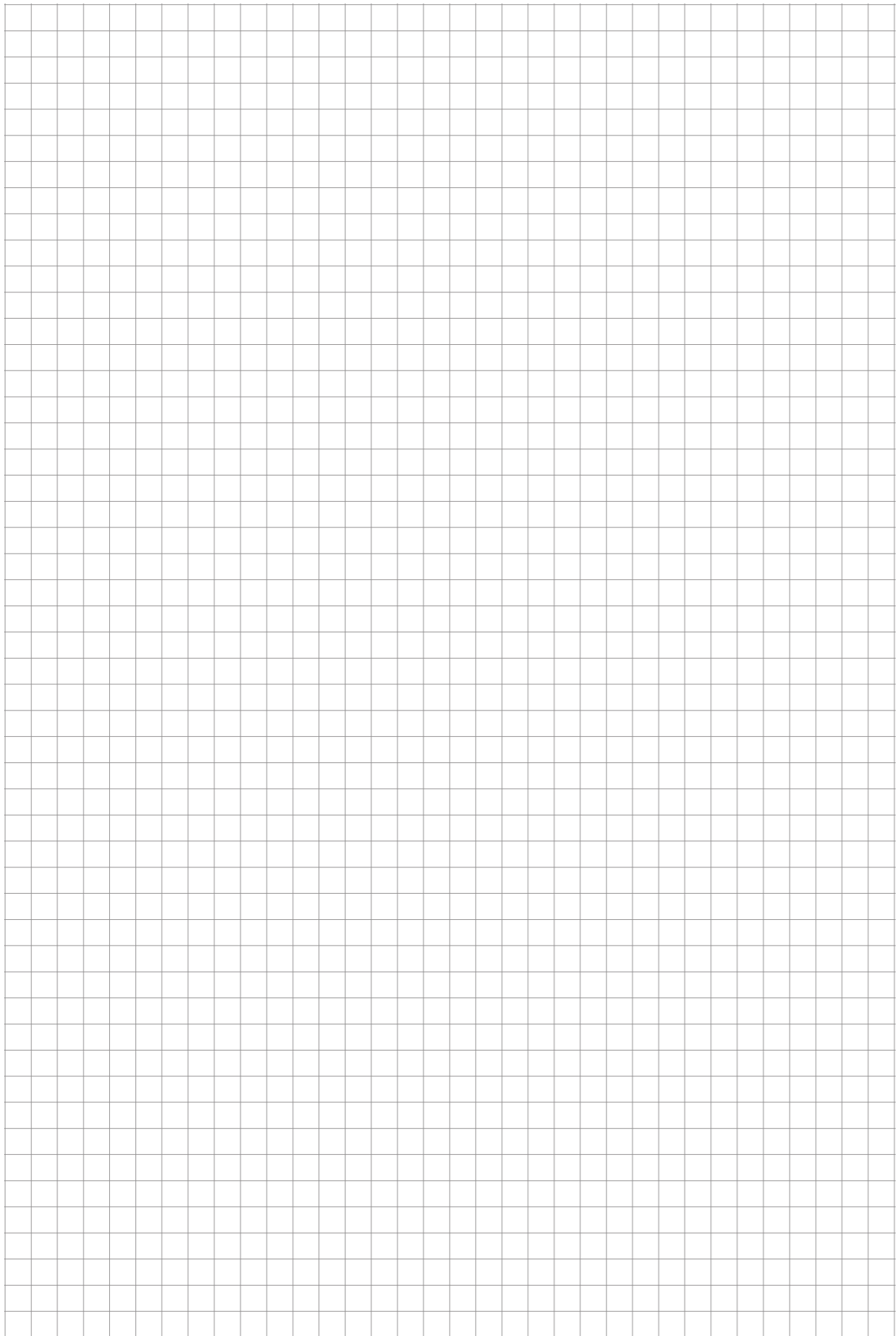

Southern Design Group

Australia (Head Office)

P 08 8362 1133

E info@tradco.com.au

W tradco.com.au

New Zealand

E info@tradco.co.nz

W tradco.co.nz



Scan here for more contact information

Front cover image:

0774 • Reims Lever - Long Backplate in Antique Brass • Page 24

Image Credit: Danielle Symes